

Relief Valve

20 to 380 ℓ /min
21MPa

Features

- ① Balanced piston relief valve.
- ② Optimum pressure control for hydraulic circuit allows operation as a safety valve.
- ③ A vent port enables remote control of pressure and use of an unloading circuit.

Specifications

Model No.		Nominal Diameter (Size)	Maximum Working Pressure MPa(kgf/cm ²)	Maximum Flow Rate ℓ /min	Pressure adjustment range MPa(kgf/cm ²)	Weight kg	
Screw Mounting	Gasket Mounting					T Type	G Type
R-T03- A-12 B-12	R-G03- A-12 B-12	3/8	21{214} P, X (Vent Ports)	20	* to 1{* to 10.2} * to 2.5{* to 25.5}	3.0	4.3
R-T03- 1-12 3-12	R-G03- 1-12 3-12	3/8		80	* to 7{* to 71.4} 3.5 to 21{35.7 to 214}	3.0	4.3
R-T06- 1-20 3-20	R-G06- 1-20 3-20	3/4		170	* to 7{* to 71.4} 3.5 to 21{35.7 to 214}	3.9	5.3
R-T10- 1-20 3-20	R-G10- 1-20 3-20	1 1/4		380	* to 7{* to 71.4} 3.5 to 21{35.7 to 214}	7.7	7.7

Note) See the Flow Rate - Low Pressure characteristics for information about items marked with an asterisk (*).

● Handling

- ① To adjust pressure, loosen the lock nut and then rotate the handle clockwise (rightward) to increase pressure or counterclockwise (leftward) to decrease it.
- ② Make sure that tank port back pressure is no greater than 0.2MPa {2.0kgf/cm²}. For tank piping of the A and B type pressure adjusting ranges, return directly to the tank without connecting any other piping and eliminate back pressure.
- ③ The pressure adjustment range for the high vent type is 1.3MPa {13.3kgf/cm²}. Note that R-T/G03 is not a high vent type.
- ④ When using a relief valve as a safety valve, use a pressure override that is higher than the required circuit pressure.
- ⑤ When using a remote control valve, connect piping to the relief valve port. Pipe capacity can be a source of vibration. Use of thick iron pipe with an inside diameter of no more than 4mm and a connection length of no more than three meters is recommended.
- ⑥ Pressure becomes unstable when at slow control flow rates. Use a flow rate of no less than 8 ℓ /min for the 03, 06 sizes, and 10 ℓ /min for the 10 size. Use a drain type

relief valve in the case of a flow rate that is less than the minimum flow rate.

- ⑦ Use the following table for specification when a sub plate is required.

Model No.	Pipe Diameter	Weight kg	Applicable Pump Model
MR-03-10	3/8	1.6	R-G03-* -12
MR-06-20	3/4	3.5	R-G06-* -20
MR-06X-20	1		
MR-10-20	1 1/4	8.5	R-G10-* -20
MR-10X-20	1 1/2		

- ⑧ The following are the bundled mounting bolts.

Model No.	Bolt Dimensions	Qty	Tightening Torque N·m(kgf·cm)
R-G03-* -12	M10 × 75 ℓ	4	45 to 55 {460 to 560}
R-G06-* -20	M16 × 80 ℓ	4	190 to 235 {1940 to 2400}
R-G10-* -20	M20 × 105 ℓ	4	370 to 460 {3770 to 4690}

Note) For mounting bolts, use 12T or equivalent.

Understanding Model Numbers

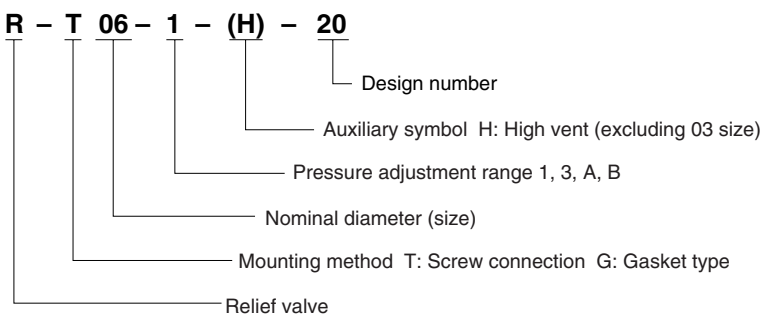

Installation Dimension Drawings

R-T03-*-12 (Screw Mounting)

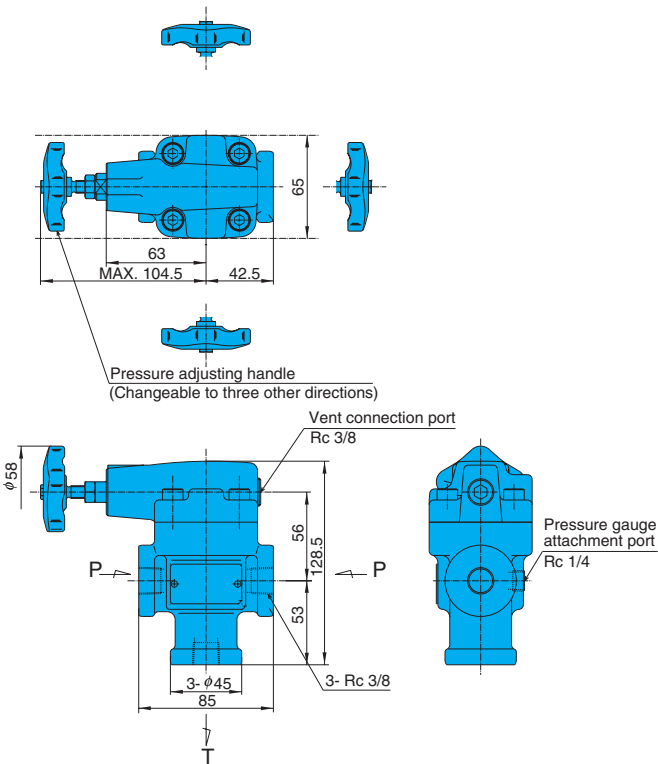

R-G03-*-12 (Gasket Mounting)

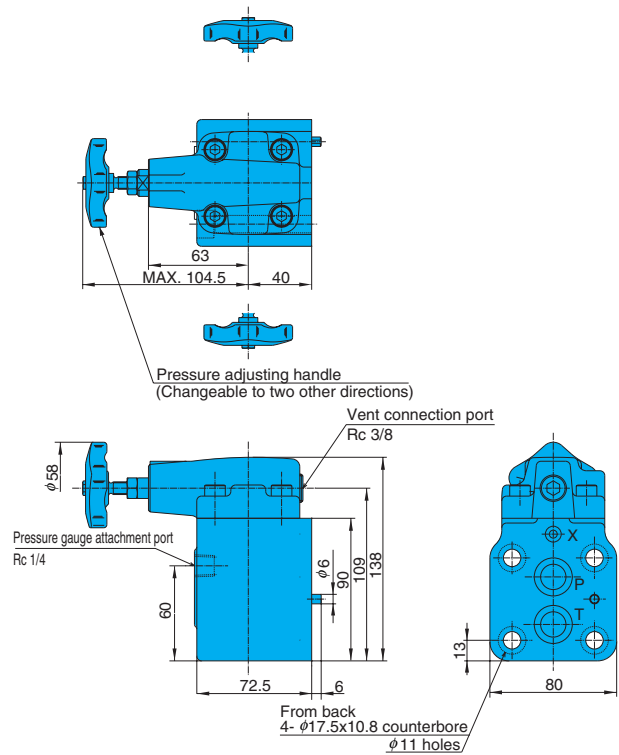

R-T**-*-20 (Screw Mounting)

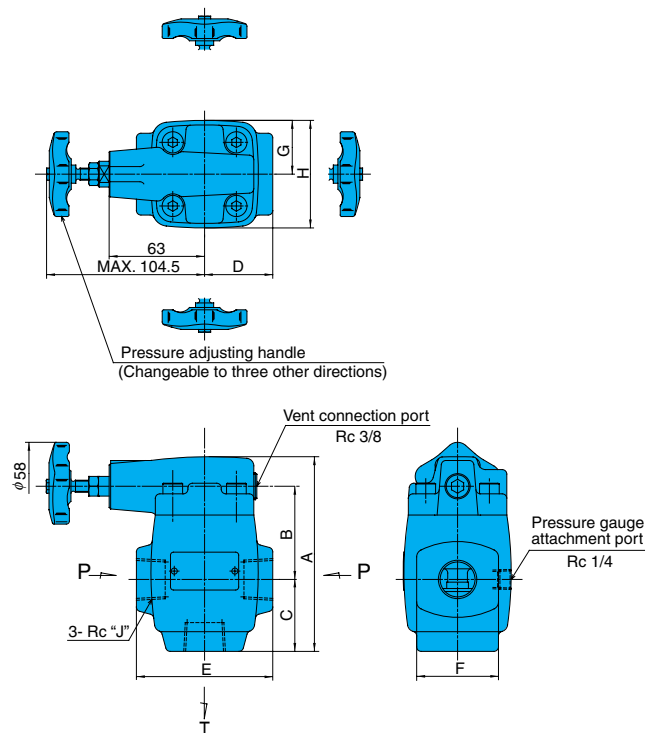

R-G**-*-20 (Gasket Mounting)

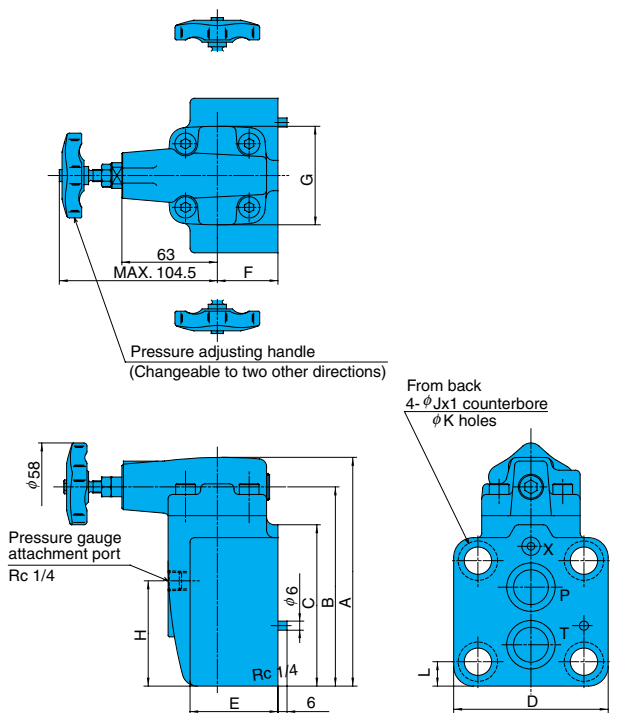

Model No.	A	B	C	D	E	F	G	H	J
R-T06-*-20	128.5	61.5	47.5	45	90	54	35.5	71	3/4
R-T10-*-20	153.5	72	62	62.5	125	69	47	94	1 1/4

Model No.	A	B	C	D	E	F	G	H	J	K	L
R-G06-*-20	151	131.5	106.5	102	58	40	65	69.5	26	18	16.1
R-G10-*-20	162.5	143	110	127	80	50	86	70.5	32	22	17.7

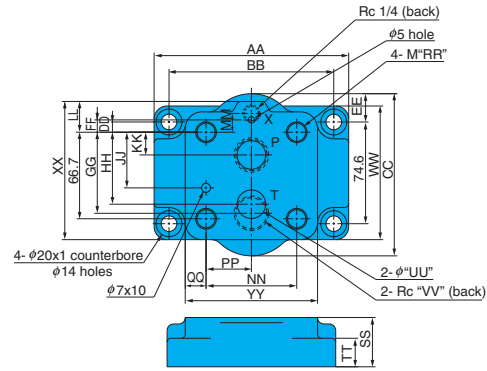
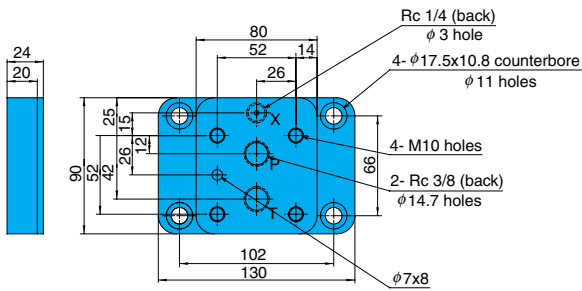

Model No.	Dimensions (mm)																						
	AA	BB	CC	DD	EE	FF	GG	HH	JJ	KK	LL	MM	NN	PP	QQ	RR	SS	TT	UU	VV	WW	XX	YY
MR-06-20	150	127	125	7.9	21.8	9.5	62.5	55.5	42.9	17.5	23.7	14.5	69.9	34.9	16.1	16	38	22	22	3/4	98.5	106.5	102
MR-06X-20																				1			
MR-10-20	175	152.4	150	6.4	39.2	15.9	71.3	58.7	50.8	14.3	25.6	25.9	92.1	46.1	17.5	20	55	22	28.5	1 1/4	102.5	110	127
MR-10X-20																				1 1/2			

Performance Curves

Hydraulic Operating Fluid Viscosity 32mm²/s

Pressure - Flow Rate Characteristics

R-*03-**-12

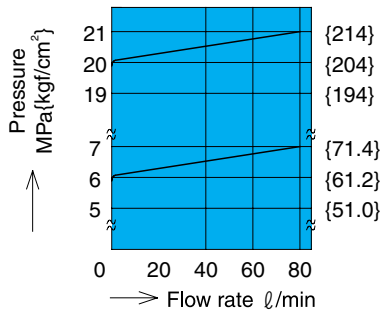

R-*06-**-20

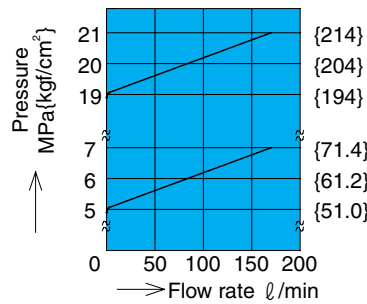

R-*10-**-20

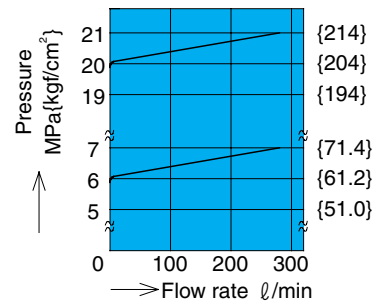

Flow Rate - Minimum Pressure Characteristics

R-03-**-12

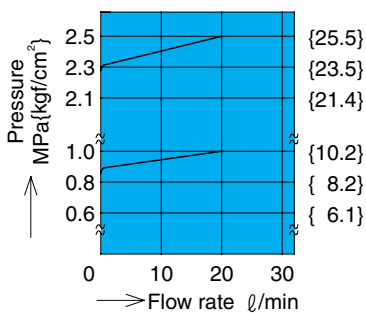

R-03-**-12

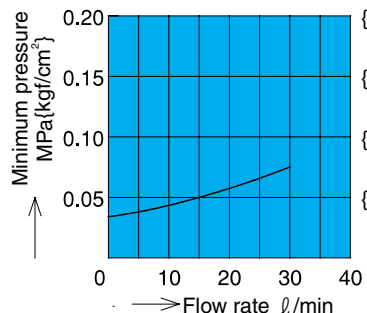

R-03-1-12

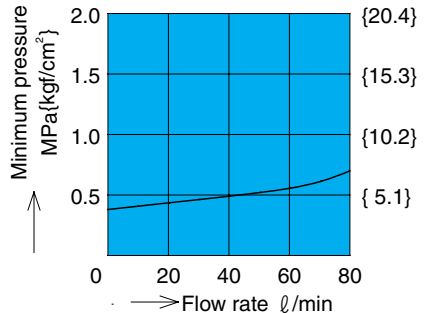

R-06-1-20

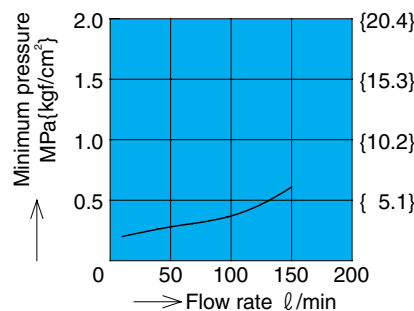

R-10-1-20

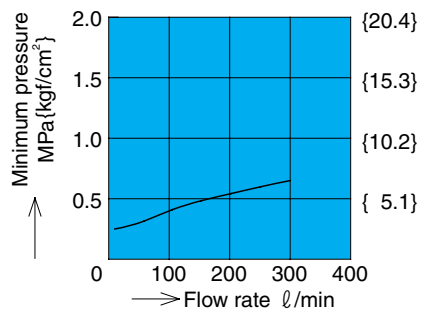

Note) The performance curves do not include T port back pressure.

Cross-sectional Drawing

R-G03-^A/_B-12

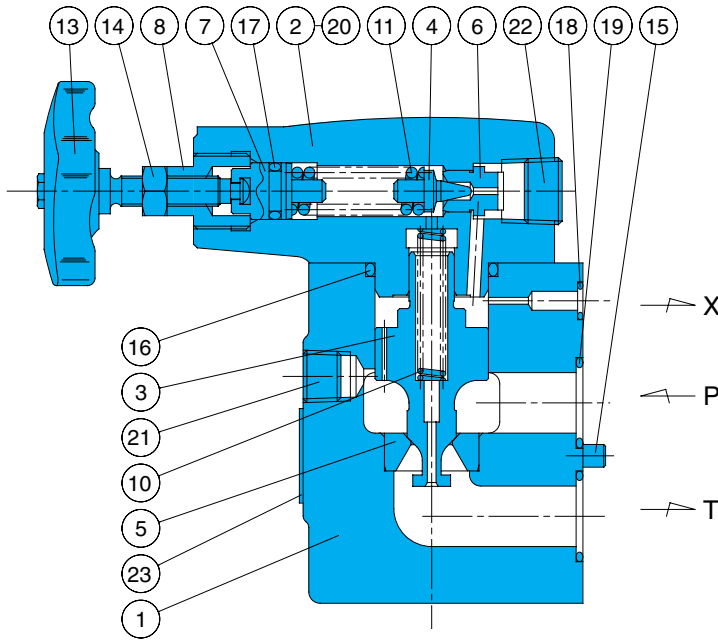

R-G03-¹/₃-12

R-G^{06 1}/_{10 3}-20

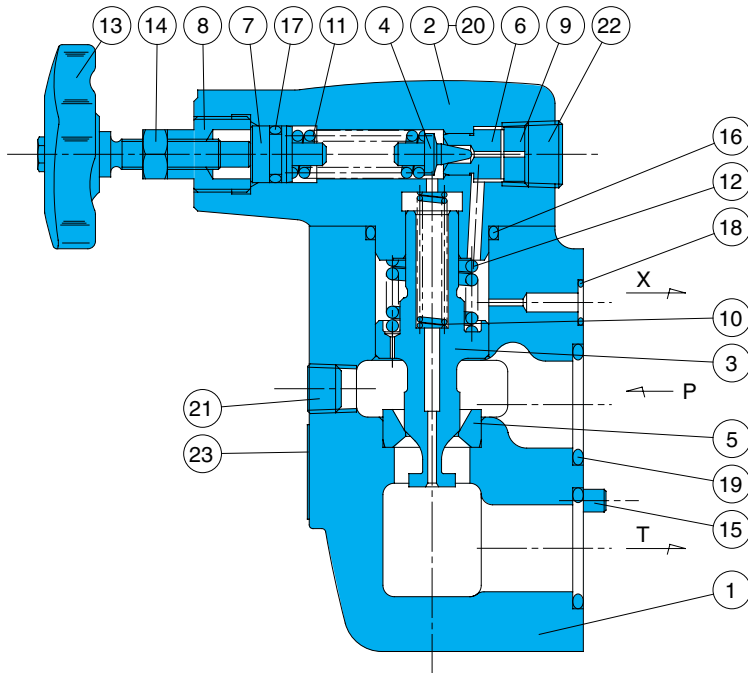

Part No.	Part Name
1	Body
2	Cover
3	Spool
4	Poppet
5	Seat
6	Seat
7	Plunger
8	Retainer
9	Collar
10	Spring
11	Spring
12	Spring
13	Handle
14	Nut
15	Spring pin
16	O-ring
17	O-ring
18	O-ring
19	O-ring
20	Screw
21	Plug
22	Plug
23	Nameplate

Note)
The No. 12 spring is not included when auxiliary symbol H is selected (except with the 03 size).

Seal Part List (Kit Model Number RRS-*** (03 size)
RRBS-*** (06, 10 size))

Part No.	Part Name	Type/Part Number						Q'ty
		R-G03*-12	R-T03*-12	R-G06*-20	R-T06*-20	R-G10*-20	R-T10*-20	
16	O-ring	IB-G30	IB-G30	IB-G30	IB-G30	IB-G40	IB-G40	1
17	O-ring	IA-P11	IA-P11	IA-P11	IA-P11	IA-P11	IA-P11	1
18	O-ring	IB-P7	-	IB-P9	-	IB-P9	-	1
19	O-ring	IB-P20	-	IB-P26	-	IB-G35	-	2

Note) O-ring 1A/B-** refers to JIS B2401-1A/B.
*** in the kit number is used for specification of the valve size (G03, T06, etc.)