

**Long lasting spool design**

**High flow compact valves**

**Wide range of operators and voltages available**

**Three functional types: available in 3/2, 5/2, and 5/3 configurations**

**Easily repairable**



### Technical data

**Medium:**

40 µm Filtered and lubricated or non-lubricated compressed air or vacuum.

**Operation:**

Spool valve solenoid pilot actuated

**Mounting:**

Inline – through holes in valve body

**Port Size:**

NPT – 1/4", 3/8", 1/2"

ISO G – 1/4", 3/8"

**Operating Pressure:**

Maximum 150 psig (10.3 bar)

**Operating Temperature:**

-20° to 120°F (-29° to 50°C)

Consult Technical Service for use below 35°F (2°C)

**Materials:**

Body: Aluminum

Spool: Anodized aluminum

Solenoid Operator Base: plastic

Plunger and spring: Stainless steel

Elastomers: Nitrile and special

nitrile-based low-friction elastomers.

### Minimum Pilot Pressures

Operator	Return psig (bar)	Nondetent psig (bar)	Detented psig (bar)	Spring Centered
Solenoid	Solenoid	15 (1.0)	25 (1.7)	45 (3.1)
Solenoid	Spring	35 (2.4)	–	–

### Average Flow Factors in Cv‡ (l/min)

Valve	Port Size	Flow Path	
		Port 1 to 2 1 to 4	Port 2 to 3 4 to 5
3-Port, Inline	1/4"	1.6 (1600)	1.7 (1700)
	3/8"	1.6 (1600)	1.7 (1700)
5-Port, Inline	1/4"	1.6 (1600)	1.7 (1700)
	3/8"	1.6 (1600)	1.7 (1700)
	1/2"	1.6 (1600)	1.7 (1700)

‡ Flow Rating determined in accordance with NFPA/T3.21.3, Pneumatic fluid power – Flow test procedure and reporting method – For fixed orifice components.

**3/2 Solenoid/Spring return Normally Open**

Symbol	Model	Port Size (NPT)	Override	Pilot Supply	Voltage	Power	Operating Pressure	Pilot Pressure	Repair Kit
	K41DA00K*1KS6	1/4"	Non-locking	Internal	24 VDC	2W	35 - 150	35 - 150	54237-59
	K41DA00K*1KS61WF	1/4"	Non-locking	Internal	12 VDC	2W	35 - 150	35 - 150	54237-59
	K41DA00K*2KS6	1/4"	Locking	Internal	24 VDC	2W	35 - 150	35 - 150	54237-59
	K41DA00K*2KS61WF	1/4"	Locking	Internal	12 VDC	2W	35 - 150	35 - 150	54237-59
	K41DA00K*4KS6	1/4"	Non-locking	External	24 VDC	2W	10" Hg - 150	35 - 150	54237-59
	K41DA00K*4KS61WF	1/4"	Non-locking	External	12 VDC	2W	10" Hg - 150	35 - 150	54237-59
	K41DA00K*5KS6	1/4"	Locking	External	24 VDC	2W	10" Hg - 150	35 - 150	54237-59
	K41DA00K*5KS61WF	1/4"	Locking	External	12 VDC	2W	10" Hg - 150	35 - 150	54237-59
	K41EA00K*1KS6	3/8"	Non-locking	Internal	24 VDC	2W	35 - 150	35 - 150	54237-59
	K41EA00K*1KS61WF	3/8"	Non-locking	Internal	12 VDC	2W	35 - 150	35 - 150	54237-59
	K41EA00K*2KS6	3/8"	Locking	Internal	24 VDC	2W	35 - 150	35 - 150	54237-59
	K41EA00K*2KS61WF	3/8"	Locking	Internal	12 VDC	2W	35 - 150	35 - 150	54237-59
	K41EA00K*4KS6	3/8"	Non-locking	External	24 VDC	2W	10" Hg - 150	35 - 150	54237-59
	K41EA00K*4KS61WF	3/8"	Non-locking	External	12 VDC	2W	10" Hg - 150	35 - 150	54237-59
	K41EA00K*5KS6	3/8"	Locking	External	24 VDC	2W	10" Hg - 150	35 - 150	54237-59
	K41EA00K*5KS61WF	3/8"	Locking	External	12 VDC	2W	10" Hg - 150	35 - 150	54237-59

Replace \* with code below

U = Cable Grip

0 = No Connector

Order example: K41EA00KU2KS6 is a 3/2 NO, 3/8", locking override, 24 VDC with a cable grip connector.

**3/2 Solenoid/Spring return Normally Closed**

Symbol	Model	Port Size (NPT)	Override	Pilot Supply	Voltage	Power	Operating Pressure	Pilot Pressure	Repair Kit
	K41DA00KS6K*1	1/4"	Non-locking	Internal	24 VDC	2W	35 - 150	35 - 150	54237-59
	K41DA00KS6K*11WF	1/4"	Non-locking	Internal	12 VDC	2W	35 - 150	35 - 150	54237-59
	K41DA00KS6K*2	1/4"	Locking	Internal	24 VDC	2W	35 - 150	35 - 150	54237-59
	K41DA00KS6K*21WF	1/4"	Locking	Internal	12 VDC	2W	35 - 150	35 - 150	54237-59
	K41DA00KS6K*4	1/4"	Non-locking	External	24 VDC	2W	10" Hg - 150	35 - 150	54237-59
	K41DA00KS6K*41WF	1/4"	Non-locking	External	12 VDC	2W	10" Hg - 150	35 - 150	54237-59
	K41DA00KS6K*5	1/4"	Locking	External	24 VDC	2W	10" Hg - 150	35 - 150	54237-59
	K41DA00KS6K*51WF	1/4"	Locking	External	12 VDC	2W	10" Hg - 150	35 - 150	54237-59
	K41EA00KS6K*1	3/8"	Non-locking	Internal	24 VDC	2W	35 - 150	35 - 150	54237-59
	K41EA00KS6K*11WF	3/8"	Non-locking	Internal	12 VDC	2W	35 - 150	35 - 150	54237-59
	K41EA00KS6K*2	3/8"	Locking	Internal	24 VDC	2W	35 - 150	35 - 150	54237-59
	K41EA00KS6K*21WF	3/8"	Locking	Internal	12 VDC	2W	35 - 150	35 - 150	54237-59
	K41EA00KS6K*4	3/8"	Non-locking	External	24 VDC	2W	10" Hg - 150	35 - 150	54237-59
	K41EA00KS6K*41WF	3/8"	Non-locking	External	12 VDC	2W	10" Hg - 150	35 - 150	54237-59
	K41EA00KS6K*5	3/8"	Locking	External	24 VDC	2W	10" Hg - 150	35 - 150	54237-59
	K41EA00KS6K*51WF	3/8"	Locking	External	12 VDC	2W	10" Hg - 150	35 - 150	54237-59

Replace \* with code below

U = Cable Grip

0 = No Connector

Order example: K41DA00KS6K021WF is a 3/2 NC, 1/4", locking override, 24 VDC, no connector.

**Note: Additional voltages, add or replace the 1W2 or 2W2 above with the code from table below in the desired part number**

Voltage	Single Solenoid	Double Solenoid
12 VDC	1W1	2W1
24V 50/60 Hz	1W4	2W4
220/240V, 50/60 Hz	1W6	2W6

K41DA00KS6KV2 110/120V, 50/60Hz changed to a 12 VDC option

K71DA00KS6KV21W1

K71EA00KV2KV22W2 24 VDC changed to a 220/240V, 50/60 Hz option

K71EA00KV2KV22W6

K81FA00KV2KV22W2 24 VDC changed to a 24V, 50/60 Hz option

K71FA00KV2KV22W4

**3/2 Solenoid/Solenoid**

Symbol	Model	Port Size (NPT)	Override	Pilot Supply	Voltage	Power	Operating Pressure	Pilot Pressure	Repair Kit
	K41DA00K*1K*1	1/4"	Non-locking	Internal	24 VDC	2W	35 - 150	35 - 150	54237-59
	K41DA00K*1K*12WF	1/4"	Non-locking	Internal	12 VDC	2W	35 - 150	35 - 150	54237-59
	K41DA00K*2K*2	1/4"	Locking	Internal	24 VDC	2W	35 - 150	35 - 150	54237-59
	K41DA00K*2K*22WF	1/4"	Locking	Internal	12 VDC	2W	35 - 150	35 - 150	54237-59
	K41DA00K*4K*4	1/4"	Non-locking	External	24 VDC	2W	10" Hg - 150	35 - 150	54237-59
	K41DA00K*4K*42WF	1/4"	Non-locking	External	12 VDC	2W	10" Hg - 150	35 - 150	54237-59
	K41DA00K*5K*5	1/4"	Locking	External	24 VDC	2W	10" Hg - 150	35 - 150	54237-59
	K41DA00K*5K*52WF	1/4"	Locking	External	12 VDC	2W	10" Hg - 150	35 - 150	54237-59
	K41EA00K*1K*1	3/8"	Non-locking	Internal	24 VDC	2W	35 - 150	35 - 150	54237-59
	K41EA00K*1K*12WF	3/8"	Non-locking	Internal	12 VDC	2W	35 - 150	35 - 150	54237-59
	K41EA00K*2K*2	3/8"	Locking	Internal	24 VDC	2W	35 - 150	35 - 150	54237-59
	K41EA00K*2K*22WF	3/8"	Locking	Internal	12 VDC	2W	35 - 150	35 - 150	54237-59
	K41EA00K*4K*4	3/8"	Non-locking	External	24 VDC	2W	10" Hg - 150	35 - 150	54237-59
	K41EA00K*4K*42WF	3/8"	Non-locking	External	12 VDC	2W	10" Hg - 150	35 - 150	54237-59
	K41EA00K*5K*5	3/8"	Locking	External	24 VDC	2W	10" Hg - 150	35 - 150	54237-59
	K41EA00K*5K*52WF	3/8"	Locking	External	12 VDC	2W	10" Hg - 150	35 - 150	54237-59

Replace \* with code below

U = Cable Grip

0 = No Connector

Order example: K41DA00K01K01 is a 3/2, 1/4", non-locking override, 24 VDC, no connector.

**5/2 Solenoid /Spring Return**

Symbol	Model	Port Size (NPT)	Override	Pilot Supply	Voltage	Power	Operating Pressure	Pilot Pressure	Repair Kit
	K71DA00KS6K*1	1/4"	Non-locking	Internal	24 VDC	2W	35 - 150	35 - 150	54237-56
	K71DA00KS6K*11WF	1/4"	Non-locking	Internal	12 VDC	2W	35 - 150	35 - 150	54237-56
	K71DA00KS6K*2	1/4"	Locking	Internal	24 VDC	2W	35 - 150	35 - 150	54237-56
	K71DA00KS6K*21WF	1/4"	Locking	Internal	12 VDC	2W	35 - 150	35 - 150	54237-56
	K71DA00KS6K*4	1/4"	Non-locking	External	24 VDC	2W	10" Hg - 150	35 - 150	54237-56
	K71DA00KS6K*41WF	1/4"	Non-locking	External	12 VDC	2W	10" Hg - 150	35 - 150	54237-56
	K71DA00KS6K*5	1/4"	Locking	External	24 VDC	2W	10" Hg - 150	35 - 150	54237-56
	K71DA00KS6K*51WF	1/4"	Locking	External	12 VDC	2W	10" Hg - 150	35 - 150	54237-56
	K71EA00KS6K*1	3/8"	Non-locking	Internal	24 VDC	2W	35 - 150	35 - 150	54237-56
	K71EA00KS6K*11WF	3/8"	Non-locking	Internal	12 VDC	2W	35 - 150	35 - 150	54237-56
	K71EA00KS6K*2	3/8"	Locking	Internal	24 VDC	2W	35 - 150	35 - 150	54237-56
	K71EA00KS6K*21WF	3/8"	Locking	Internal	12 VDC	2W	35 - 150	35 - 150	54237-56
	K71EA00KS6K*4	3/8"	Non-locking	External	24 VDC	2W	10" Hg - 150	35 - 150	54237-56
	K71EA00KS6K*41WF	3/8"	Non-locking	External	12 VDC	2W	10" Hg - 150	35 - 150	54237-56
	K71EA00KS6K*5	3/8"	Locking	External	24 VDC	2W	10" Hg - 150	35 - 150	54237-56
	K71EA00KS6K*51WF	3/8"	Locking	External	12 VDC	2W	10" Hg - 150	35 - 150	54237-56
	K71FA00KS6K*1	1/2"	Non-locking	Internal	24 VDC	2W	35 - 150	35 - 150	54237-56
	K71FA00KS6K*11WF	1/2"	Non-locking	Internal	12 VDC	2W	35 - 150	35 - 150	54237-56
	K71FA00KS6K*2	1/2"	Locking	Internal	24 VDC	2W	35 - 150	35 - 150	54237-56
	K71FA00KS6K*21WF	1/2"	Locking	Internal	12 VDC	2W	35 - 150	35 - 150	54237-56
	K71FA00KS6K*4	1/2"	Non-locking	External	24 VDC	2W	10" Hg - 150	35 - 150	54237-56
	K71FA00KS6K*41WF	1/2"	Non-locking	External	12 VDC	2W	10" Hg - 150	35 - 150	54237-56
	K71FA00KS6K*5	1/2"	Locking	External	24 VDC	2W	10" Hg - 150	35 - 150	54237-56
	K71FA00KS6K*51WF	1/2"	Locking	External	12 VDC	2W	10" Hg - 150	35 - 150	54237-56

Replace \* with code below

U = Cable Grip

0 = No Connector

Order example: K71FA00KS6KUL1WF is a 5/2, 1/2", non-locking override, 24 VDC, with cable grip connector.

**5/2 Double Solenoid**

Symbol	Model	Port Size (NPT)	Override	Pilot Supply	Voltage	Power	Operating Pressure	Pilot Pressure	Repair Kit
	K71DA00K*1K*1	1/4"	Non-locking	Internal	24 VDC	2W	15 - 150	15 - 150	54237-56
	K71DA00K*1K*12WF	1/4"	Non-locking	Internal	12 VDC	2W	15 - 150	15 - 150	54237-56
	K71DA00K*2K*2	1/4"	Locking	Internal	24 VDC	2W	15 - 150	15 - 150	54237-56
	K71DA00K*2K*22WF	1/4"	Locking	Internal	12 VDC	2W	15 - 150	15 - 150	54237-56
	K71DA00K*4K*4	1/4"	Non-locking	External	24 VDC	2W	10" Hg - 150	15 - 150	54237-56
	K71DA00K*4K*42WF	1/4"	Non-locking	External	12 VDC	2W	10" Hg - 150	15 - 150	54237-56
	K71DA00K*5K*5	1/4"	Locking	External	24 VDC	2W	10" Hg - 150	15 - 150	54237-56
	K71DA00K*5K*52WF	1/4"	Locking	External	12 VDC	2W	10" Hg - 150	15 - 150	54237-56
	K71EA00K*1K*1	3/8"	Non-locking	Internal	24 VDC	2W	15 - 150	15 - 150	54237-56
	K71EA00K*1K*12WF	3/8"	Non-locking	Internal	12 VDC	2W	15 - 150	15 - 150	54237-56
	K71EA00K*2K*2	3/8"	Locking	Internal	24 VDC	2W	15 - 150	15 - 150	54237-56
	K71EA00K*2K*22WF	3/8"	Locking	Internal	12 VDC	2W	15 - 150	15 - 150	54237-56
	K71EA00K*4K*4	3/8"	Non-locking	External	24 VDC	2W	10" Hg - 150	15 - 150	54237-56
	K71EA00K*4K*42WF	3/8"	Non-locking	External	12 VDC	2W	10" Hg - 150	15 - 150	54237-56
	K71EA00K*5K*5	3/8"	Locking	External	24 VDC	2W	10" Hg - 150	15 - 150	54237-56
	K71EA00K*5K*52WF	3/8"	Locking	External	12 VDC	2W	10" Hg - 150	15 - 150	54237-56
	K71FA00K*1K*1	1/2"	Non-locking	Internal	24 VDC	2W	15 - 150	15 - 150	54237-56
	K71FA00K*1K*12WF	1/2"	Non-locking	Internal	12 VDC	2W	15 - 150	15 - 150	54237-56
	K71FA00K*2K*2	1/2"	Locking	Internal	24 VDC	2W	15 - 150	15 - 150	54237-56
	K71FA00K*2K*22WF	1/2"	Locking	Internal	12 VDC	2W	15 - 150	15 - 150	54237-56
	K71FA00K*4K*4	1/2"	Non-locking	External	24 VDC	2W	10" Hg - 150	15 - 150	54237-56
	K71FA00K*4K*42WF	1/2"	Non-locking	External	12 VDC	2W	10" Hg - 150	15 - 150	54237-56
	K71FA00K*5K*5	1/2"	Locking	External	24 VDC	2W	10" Hg - 150	15 - 150	54237-56
	K71FA00K*5K*52WF	1/2"	Locking	External	12 VDC	2W	10" Hg - 150	15 - 150	54237-56

Replace \* with code below

U = Cable Grip  
 0 = No Connector

Order example: K71EA00KU2KU2 is a 5/2, 3/8", locking override, 24 VDC, with cable grip connector.

**Note: Additional voltages, add or replace the 1W2 or 2W2 above with the code from table below in the desired part number**

Voltage	Single Solenoid	Double Solenoid
12 VDC	1W1	2W1
24V 50/60 Hz	1W4	2W4
220/240V, 50/60 Hz	1W6	2W6

K41DA00KS6KV2 110/120V, 50/60Hz changed to a 12 VDC option  
 K71DA00KS6KV21W1  
 K71EA00KV2KV22W2 24 VDC changed to a 220/240V, 50/60 Hz option  
 K71EA00KV2KV22W6  
 K81FA00KV2KV22W2 24 VDC changed to a 24V, 50/60 Hz option  
 K71FA00KV2KV22W4

**5/3 All Ports Blocked**

Symbol	Model	Port Size (NPT)	Override	Pilot Supply	Voltage	Power	Operating Pressure	Pilot Pressure	Repair Kit
	K81DA00K*8K*8	1/4"	Non-locking	Internal	24 VDC	2W	45 - 150	45 - 150	54237-56
	K81DA00K*8K*82WF	1/4"	Non-locking	Internal	12 VDC	2W	45 - 150	45 - 150	54237-56
	K81DA00K*0K*0	1/4"	Locking	Internal	24 VDC	2W	45 - 150	45 - 150	54237-56
	K81DA00K*0K*02WF	1/4"	Locking	Internal	12 VDC	2W	45 - 150	45 - 150	54237-56
	K81DA00K*9K*9	1/4"	Non-locking	External	24 VDC	2W	10" Hg - 150	45 - 150	54237-56
	K81DA00K*9K*92WF	1/4"	Non-locking	External	12 VDC	2W	10" Hg - 150	45 - 150	54237-56
	K81DA00K*3K*3	1/4"	Locking	External	24 VDC	2W	10" Hg - 150	45 - 150	54237-56
	K81DA00K*3K*32WF	1/4"	Locking	External	12 VDC	2W	10" Hg - 150	45 - 150	54237-56
	K81EA00K*8K*8	3/8"	Non-locking	Internal	24 VDC	2W	45 - 150	45 - 150	54237-56
	K81EA00K*8K*82WF	3/8"	Non-locking	Internal	12 VDC	2W	45 - 150	45 - 150	54237-56
	K81EA00K*0K*0	3/8"	Locking	Internal	24 VDC	2W	45 - 150	45 - 150	54237-56
	K81EA00K*0K*02WF	3/8"	Locking	Internal	12 VDC	2W	45 - 150	45 - 150	54237-56
	K81EA00K*9K*9	3/8"	Non-locking	External	24 VDC	2W	10" Hg - 150	45 - 150	54237-56
	K81EA00K*9K*92WF	3/8"	Non-locking	External	12 VDC	2W	10" Hg - 150	45 - 150	54237-56
	K81EA00K*3K*3	3/8"	Locking	External	24 VDC	2W	10" Hg - 150	45 - 150	54237-56
	K81EA00K*3K*32WF	3/8"	Locking	External	12 VDC	2W	10" Hg - 150	45 - 150	54237-56
	K81FA00K*8K*8	1/2"	Non-locking	Internal	24 VDC	2W	45 - 150	45 - 150	54237-56
	K81FA00K*8K*82WF	1/2"	Non-locking	Internal	12 VDC	2W	45 - 150	45 - 150	54237-56
	K81FA00K*0K*0	1/2"	Locking	Internal	24 VDC	2W	45 - 150	45 - 150	54237-56
	K81FA00K*0K*02WF	1/2"	Locking	Internal	12 VDC	2W	45 - 150	45 - 150	54237-56
	K81FA00K*9K*9	1/2"	Non-locking	External	24 VDC	2W	10" Hg - 150	45 - 150	54237-56
	K81FA00K*9K*92WF	1/2"	Non-locking	External	12 VDC	2W	10" Hg - 150	45 - 150	54237-56
	K81FA00K*3K*3	1/2"	Locking	External	24 VDC	2W	10" Hg - 150	45 - 150	54237-56
	K81FA00K*3K*32WF	1/2"	Locking	External	12 VDC	2W	10" Hg - 150	45 - 150	54237-56

**Replace \* with code below**

U = Cable Grip  
 0 = No Connector

Order example: K81DA00K09K09 is a 5/3 APB, 1/4", non-locking override, external pilot, 24 VDC, with no connector.

**Note: Additional voltages, add or replace the 1W2 or 2W2 above with the code from table below in the desired part number**

Voltage	Single Solenoid	Double Solenoid
12 VDC	1W1	2W1
24V 50/60 Hz	1W4	2W4
220/240V, 50/60 Hz	1W6	2W6

K41DA00KS6KV2 110/120V, 50/60Hz changed to a 12 VDC option  
 K71DA00KS6KV21W1  
 K71EA00KV2KV22W2 24 VDC changed to a 220/240V, 50/60 Hz option  
 K71EA00KV2KV22W6  
 K81FA00KV2KV22W2 24 VDC changed to a 24V, 50/60 Hz option  
 K71FA00KV2KV22W4

**5/3 Center Open to Exhaust**

Symbol	Model	Port Size (NPT)	Override	Pilot Supply	Voltage	Power	Operating Pressure	Pilot Pressure	Repair Kit
	K81DA06K*8K*8	1/4"	Non-locking	Internal	24 VDC	2W	45 - 150	45 - 150	54237-58
	K81DA06K*8K*82WF	1/4"	Non-locking	Internal	12 VDC	2W	45 - 150	45 - 150	54237-58
	K81DA06K*0K*0	1/4"	Locking	Internal	24 VDC	2W	45 - 150	45 - 150	54237-58
	K81DA06K*0K*02WF	1/4"	Locking	Internal	12 VDC	2W	45 - 150	45 - 150	54237-58
	K81DA06K*9K*9	1/4"	Non-locking	External	24 VDC	2W	10" Hg - 150	45 - 150	54237-58
	K81DA06K*9K*92WF	1/4"	Non-locking	External	12 VDC	2W	10" Hg - 150	45 - 150	54237-58
	K81DA06K*3K*3	1/4"	Locking	External	24 VDC	2W	10" Hg - 150	45 - 150	54237-58
	K81DA06K*3K*32WF	1/4"	Locking	External	12 VDC	2W	10" Hg - 150	45 - 150	54237-58
	K81EA06K*8K*8	3/8"	Non-locking	Internal	24 VDC	2W	45 - 150	45 - 150	54237-58
	K81EA06K*8K*82WF	3/8"	Non-locking	Internal	12 VDC	2W	45 - 150	45 - 150	54237-58
	K81EA06K*0K*0	3/8"	Locking	Internal	24 VDC	2W	45 - 150	45 - 150	54237-58
	K81EA06K*0K*02WF	3/8"	Locking	Internal	12 VDC	2W	45 - 150	45 - 150	54237-58
	K81EA06K*9K*9	3/8"	Non-locking	External	24 VDC	2W	10" Hg - 150	45 - 150	54237-58
	K81EA06K*9K*92WF	3/8"	Non-locking	External	12 VDC	2W	10" Hg - 150	45 - 150	54237-58
	K81EA06K*3K*3	3/8"	Locking	External	24 VDC	2W	10" Hg - 150	45 - 150	54237-58
	K81EA06K*3K*32WF	3/8"	Locking	External	12 VDC	2W	10" Hg - 150	45 - 150	54237-58
	K81FA06K*8K*8	1/2"	Non-locking	Internal	24 VDC	2W	45 - 150	45 - 150	54237-58
	K81FA06K*8K*82WF	1/2"	Non-locking	Internal	12 VDC	2W	45 - 150	45 - 150	54237-58
	K81FA06K*0K*0	1/2"	Locking	Internal	24 VDC	2W	45 - 150	45 - 150	54237-58
	K81FA06K*0K*02WF	1/2"	Locking	Internal	12 VDC	2W	45 - 150	45 - 150	54237-58
	K81FA06K*9K*9	1/2"	Non-locking	External	24 VDC	2W	10" Hg - 150	45 - 150	54237-58
	K81FA06K*9K*92WF	1/2"	Non-locking	External	12 VDC	2W	10" Hg - 150	45 - 150	54237-58
	K81FA06K*3K*3	1/2"	Locking	External	24 VDC	2W	10" Hg - 150	45 - 150	54237-58
	K81FA06K*3K*32WF	1/2"	Locking	External	12 VDC	2W	10" Hg - 150	45 - 150	54237-58

Replace \* with code below

U = Cable Grip  
 0 = No Connector

Order example: K81EA06KU0KU02WF is a 5/3 COE, 3/8", locking override, 24 VDC, with cable grip connector.

**Note: Additional voltages, add or replace the 1W2 or 2W2 above with the code from table below in the desired part number**

Voltage	Single Solenoid	Double Solenoid
12 VDC	1W1	2W1
24V 50/60 Hz	1W4	2W4
220/240V, 50/60 Hz	1W6	2W6

K41DA00KS6KV2 110/120V, 50/60Hz changed to a 12 VDC option  
 K71DA00KS6KV21W1  
 K71EA00KV2KV22W2 24 VDC changed to a 220/240V, 50/60 Hz option  
 K71EA00KV2KV22W6  
 K81FA00KV2KV22W2 24 VDC changed to a 24V, 50/60 Hz option  
 K71FA00KV2KV22W4

**5/3 Center Open to Pressure**

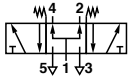
Symbol	Model	Port Size (NPT)	Override	Pilot Supply	Voltage	Power	Operating Pressure	Pilot Pressure	Repair Kit
	K81DA05K*8K*8	1/4"	Non-locking	Internal	24 VDC	2W	45 - 150	45 - 150	54237-57
	K81DA05K*8K*82WF	1/4"	Non-locking	Internal	12 VDC	2W	45 - 150	45 - 150	54237-57
	K81DA05K*0K*0	1/4"	Locking	Internal	24 VDC	2W	45 - 150	45 - 150	54237-57
	K81DA05K*0K*02WF	1/4"	Locking	Internal	12 VDC	2W	45 - 150	45 - 150	54237-57
	K81DA05K*9K*9	1/4"	Non-locking	External	24 VDC	2W	10" Hg - 150	45 - 150	54237-57
	K81DA05K*9K*92WF	1/4"	Non-locking	External	12 VDC	2W	10" Hg - 150	45 - 150	54237-57
	K81DA05K*3K*3	1/4"	Locking	External	24 VDC	2W	10" Hg - 150	45 - 150	54237-57
	K81DA05K*3K*32WF	1/4"	Locking	External	12 VDC	2W	10" Hg - 150	45 - 150	54237-57
	K81EA05K*8K*8	3/8"	Non-locking	Internal	24 VDC	2W	45 - 150	45 - 150	54237-57
	K81EA05K*8K*82WF	3/8"	Non-locking	Internal	12 VDC	2W	45 - 150	45 - 150	54237-57
	K81EA05K*0K*0	3/8"	Locking	Internal	24 VDC	2W	45 - 150	45 - 150	54237-57
	K81EA05K*0K*02WF	3/8"	Locking	Internal	12 VDC	2W	45 - 150	45 - 150	54237-57
	K81EA05K*9K*9	3/8"	Non-locking	External	24 VDC	2W	10" Hg - 150	45 - 150	54237-57
	K81EA05K*9K*92WF	3/8"	Non-locking	External	12 VDC	2W	10" Hg - 150	45 - 150	54237-57
	K81EA05K*3K*3	3/8"	Locking	External	24 VDC	2W	10" Hg - 150	45 - 150	54237-57
	K81EA05K*3K*32WF	3/8"	Locking	External	12 VDC	2W	10" Hg - 150	45 - 150	54237-57
	K81FA05K*8K*8	1/2"	Non-locking	Internal	24 VDC	2W	45 - 150	45 - 150	54237-57
	K81FA05K*8K*82WF	1/2"	Non-locking	Internal	12 VDC	2W	45 - 150	45 - 150	54237-57
	K81FA05K*0K*0	1/2"	Locking	Internal	24 VDC	2W	45 - 150	45 - 150	54237-57
	K81FA05K*0K*02WF	1/2"	Locking	Internal	12 VDC	2W	45 - 150	45 - 150	54237-57
	K81FA05K*9K*9	1/2"	Non-locking	External	24 VDC	2W	10" Hg - 150	45 - 150	54237-57
	K81FA05K*9K*92WF	1/2"	Non-locking	External	12 VDC	2W	10" Hg - 150	45 - 150	54237-57
	K81FA05K*3K*3	1/2"	Locking	External	24 VDC	2W	10" Hg - 150	45 - 150	54237-57
	K81FA05K*3K*32WF	1/2"	Locking	External	12 VDC	2W	10" Hg - 150	45 - 150	54237-57

**Replace \* with code below**

U = Cable Grip

0 = No Connector

Order example: K81FA05KU0KU0 is a 5/3 COE, 1/2", locking override, 24 VDC, with cable grip connector.

**3/2 Solenoid/Spring return Normally Open**

Symbol	Model	Port Size (NPT)	Override	Pilot Supply	Voltage	Power	Operating Pressure	Pilot Pressure	Repair Kit
	K41DA00K*1KS6	1/4"	Non-locking	Internal	110/120 V, 50/60 Hz	7W	35 - 150	35 - 150	54237-59
	K41DA00K*1KS61W2	1/4"	Non-locking	Internal	24 VDC	6W	35 - 150	35 - 150	54237-59
	K41DA00K*2KS6	1/4"	Locking	Internal	110/120 V, 50/60 Hz	7W	35 - 150	35 - 150	54237-59
	K41DA00K*2KS61W2	1/4"	Locking	Internal	24 VDC	6W	35 - 150	35 - 150	54237-59
	K41DA00K*4KS6	1/4"	Non-locking	External	110/120 V, 50/60 Hz	7W	10" Hg - 150	35 - 150	54237-59
	K41DA00K*4KS61W2	1/4"	Non-locking	External	24 VDC	6W	10" Hg - 150	35 - 150	54237-59
	K41DA00K*5KS6	1/4"	Locking	External	110/120 V, 50/60 Hz	7W	10" Hg - 150	35 - 150	54237-59
	K41DA00K*5KS61W2	1/4"	Locking	External	24 VDC	6W	10" Hg - 150	35 - 150	54237-59
	K41EA00K*1KS6	3/8"	Non-locking	Internal	110/120 V, 50/60 Hz	7W	35 - 150	35 - 150	54237-59
	K41EA00K*1KS61W2	3/8"	Non-locking	Internal	24 VDC	6W	35 - 150	35 - 150	54237-59
	K41EA00K*2KS6	3/8"	Locking	Internal	110/120 V, 50/60 Hz	7W	35 - 150	35 - 150	54237-59
	K41EA00K*2KS61W2	3/8"	Locking	Internal	24 VDC	6W	35 - 150	35 - 150	54237-59
	K41EA00K*4KS6	3/8"	Non-locking	External	110/120 V, 50/60 Hz	7W	10" Hg - 150	35 - 150	54237-59
	K41EA00K*4KS61W2	3/8"	Non-locking	External	24 VDC	6W	10" Hg - 150	35 - 150	54237-59
	K41EA00K*5KS6	3/8"	Locking	External	110/120 V, 50/60 Hz	7W	10" Hg - 150	35 - 150	54237-59
	K41EA00K*5KS61W2	3/8"	Locking	External	24 VDC	6W	10" Hg - 150	35 - 150	54237-59

Replace \* with code below  
**Connector Options Code**

V = Cable Grip  
 3 = 1/2" Conduit  
 1 = No Connector

Order example: K41DA00KV1KS6 is a 3/2 NO, 1/4", Non-locking override, 110/120V, with cable grip connector.

**3/2 Solenoid/Spring return Normally Closed**

Symbol	Model	Port Size (NPT)	Override	Pilot Supply	Voltage	Power	Operating Pressure	Pilot Pressure	Repair Kit
	K41DA00KS6K*1	1/4"	Non-locking	Internal	110/120 V, 50/60 Hz	7W	35 - 150	35 - 150	54237-59
	K41DA00KS6K*11W2	1/4"	Non-locking	Internal	24 VDC	6W	35 - 150	35 - 150	54237-59
	K41DA00KS6K*2	1/4"	Locking	Internal	110/120 V, 50/60 Hz	7W	35 - 150	35 - 150	54237-59
	K41DA00KS6K*21W2	1/4"	Locking	Internal	24 VDC	6W	35 - 150	35 - 150	54237-59
	K41DA00KS6K*4	1/4"	Non-locking	External	110/120 V, 50/60 Hz	7W	10" Hg - 150	35 - 150	54237-59
	K41DA00KS6K*41W2	1/4"	Non-locking	External	24 VDC	6W	10" Hg - 150	35 - 150	54237-59
	K41DA00KS6K*5	1/4"	Locking	External	110/120 V, 50/60 Hz	7W	10" Hg - 150	35 - 150	54237-59
	K41DA00KS6K*51W2	1/4"	Locking	External	24 VDC	6W	10" Hg - 150	35 - 150	54237-59
	K41EA00KS6K*1	3/8"	Non-locking	Internal	110/120 V, 50/60 Hz	7W	35 - 150	35 - 150	54237-59
	K41EA00KS6K*11W2	3/8"	Non-locking	Internal	24 VDC	6W	35 - 150	35 - 150	54237-59
	K41EA00KS6K*2	3/8"	Locking	Internal	110/120 V, 50/60 Hz	7W	35 - 150	35 - 150	54237-59
	K41EA00KS6K*21W2	3/8"	Locking	Internal	24 VDC	6W	35 - 150	35 - 150	54237-59
	K41EA00KS6K*4	3/8"	Non-locking	External	110/120 V, 50/60 Hz	7W	10" Hg - 150	35 - 150	54237-59
	K41EA00KS6K*41W2	3/8"	Non-locking	External	24 VDC	6W	10" Hg - 150	35 - 150	54237-59
	K41EA00KS6K*5	3/8"	Locking	External	110/120 V, 50/60 Hz	7W	10" Hg - 150	35 - 150	54237-59
	K41EA00KS6K*51W2	3/8"	Locking	External	24 VDC	6W	10" Hg - 150	35 - 150	54237-59

Replace \* with code below  
**Connector Options Code**

V = Cable Grip  
 3 = 1/2" Conduit  
 1 = No Connector

Order example: K41EA00KS6K31 is a 3/2 NC, 3/8", Non-locking override, 110/120V, with 1/2" conduit connector.

**Note: Additional voltages, add or replace the 1W2 or 2W2 above with the code from table below in the desired part number**

Voltage	Single Solenoid	Double Solenoid
12 VDC	1W1	2W1
24V 50/60 Hz	1W4	2W4
220/240V, 50/60 Hz	1W6	2W6

K41DA00KS6KV2 110/120V, 50/60Hz changed to a 12 VDC option is K71DA00KS6KV21W1  
 K71EA00KV2KV22W2 24 VDC changed to a 220/240V, 50/60 Hz option is K71EA00KV2KV22W6  
 K81FA00KV2KV22W2 24 VDC changed to a 24V, 50/60 Hz option is K71FA00KV2KV22W4

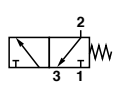

**3/2 Solenoid/Solenoid**

Symbol	Model	Port Size (NPT)	Override	Pilot Supply	Voltage	Power	Operating Pressure	Pilot Pressure	Repair Kit
	K41DA00K*1K*1	1/4"	Non-locking	Internal	110/120 V, 50/60 Hz	7W	35 - 150	35 - 150	54237-59
	K41DA00K*1K*12W2	1/4"	Non-locking	Internal	24 VDC	6W	35 - 150	35 - 150	54237-59
	K41DA00K*2K*2	1/4"	Locking	Internal	110/120 V, 50/60 Hz	7W	35 - 150	35 - 150	54237-59
	K41DA00K*2K*22W2	1/4"	Locking	Internal	24 VDC	6W	35 - 150	35 - 150	54237-59
	K41DA00K*4K*4	1/4"	Non-locking	External	110/120 V, 50/60 Hz	7W	10" Hg - 150	35 - 150	54237-59
	K41DA00K*4K*42W2	1/4"	Non-locking	External	24 VDC	6W	10" Hg - 150	35 - 150	54237-59
	K41DA00K*5K*5	1/4"	Locking	External	110/120 V, 50/60 Hz	7W	10" Hg - 150	35 - 150	54237-59
	K41DA00K*5K*52W2	1/4"	Locking	External	24 VDC	6W	10" Hg - 150	35 - 150	54237-59
	K41EA00K*1K*1	3/8"	Non-locking	Internal	110/120 V, 50/60 Hz	7W	35 - 150	35 - 150	54237-59
	K41EA00K*1K*12W2	3/8"	Non-locking	Internal	24 VDC	6W	35 - 150	35 - 150	54237-59
	K41EA00K*2K*2	3/8"	Locking	Internal	110/120 V, 50/60 Hz	7W	35 - 150	35 - 150	54237-59
	K41EA00K*2K*22W2	3/8"	Locking	Internal	24 VDC	6W	35 - 150	35 - 150	54237-59
	K41EA00K*4K*4	3/8"	Non-locking	External	110/120 V, 50/60 Hz	7W	10" Hg - 150	35 - 150	54237-59
	K41EA00K*4K*42W2	3/8"	Non-locking	External	24 VDC	6W	10" Hg - 150	35 - 150	54237-59
	K41EA00K*5K*5	3/8"	Locking	External	110/120 V, 50/60 Hz	7W	10" Hg - 150	35 - 150	54237-59
	K41EA00K*5K*52W2	3/8"	Locking	External	24 VDC	6W	10" Hg - 150	35 - 150	54237-59

Replace \* with code below

**Connector Options Code**

V = Cable Grip

3 = 1/2" Conduit

1 = No Connector

Order example: K41EA00K11K112W2 is a 3/2, 3/8", non-locking override, 24 VDC, with no connector.

**5/2 Solenoid /Spring Return**

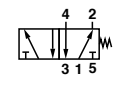
Symbol	Model	Port Size (NPT)	Override	Pilot Supply	Voltage	Power	Operating Pressure	Pilot Pressure	Repair Kit
	K71DA00KS6K*1	1/4"	Non-locking	Internal	110/120 V, 50/60 Hz	7W	35 - 150	35 - 150	54237-56
	K71DA00KS6K*11W2	1/4"	Non-locking	Internal	24 VDC	6W	35 - 150	35 - 150	54237-56
	K71DA00KS6K*2	1/4"	Locking	Internal	110/120 V, 50/60 Hz	7W	35 - 150	35 - 150	54237-56
	K71DA00KS6K*21W2	1/4"	Locking	Internal	24 VDC	6W	35 - 150	35 - 150	54237-56
	K71DA00KS6K*4	1/4"	Non-locking	External	110/120 V, 50/60 Hz	7W	10" Hg - 150	35 - 150	54237-56
	K71DA00KS6K*41W2	1/4"	Non-locking	External	24 VDC	6W	10" Hg - 150	35 - 150	54237-56
	K71DA00KS6K*5	1/4"	Locking	External	110/120 V, 50/60 Hz	7W	10" Hg - 150	35 - 150	54237-56
	K71DA00KS6K*51W2	1/4"	Locking	External	24 VDC	6W	10" Hg - 150	35 - 150	54237-56
	K71EA00KS6K*1	3/8"	Non-locking	Internal	110/120 V, 50/60 Hz	7W	35 - 150	35 - 150	54237-56
	K71EA00KS6K*11W2	3/8"	Non-locking	Internal	24 VDC	6W	35 - 150	35 - 150	54237-56
	K71EA00KS6K*2	3/8"	Locking	Internal	110/120 V, 50/60 Hz	7W	35 - 150	35 - 150	54237-56
	K71EA00KS6K*21W2	3/8"	Locking	Internal	24 VDC	6W	35 - 150	35 - 150	54237-56
	K71EA00KS6K*4	3/8"	Non-locking	External	110/120 V, 50/60 Hz	7W	10" Hg - 150	35 - 150	54237-56
	K71EA00KS6K*41W2	3/8"	Non-locking	External	24 VDC	6W	10" Hg - 150	35 - 150	54237-56
	K71EA00KS6K*5	3/8"	Locking	External	110/120 V, 50/60 Hz	7W	10" Hg - 150	35 - 150	54237-56
	K71EA00KS6K*51W2	3/8"	Locking	External	24 VDC	6W	10" Hg - 150	35 - 150	54237-56
	K71FA00KS6K*1	1/2"	Non-locking	Internal	110/120 V, 50/60 Hz	7W	35 - 150	35 - 150	54237-56
	K71FA00KS6K*11W2	1/2"	Non-locking	Internal	24 VDC	6W	35 - 150	35 - 150	54237-56
	K71FA00KS6K*2	1/2"	Locking	Internal	110/120 V, 50/60 Hz	7W	35 - 150	35 - 150	54237-56
	K71FA00KS6K*21W2	1/2"	Locking	Internal	24 VDC	6W	35 - 150	35 - 150	54237-56
	K71FA00KS6K*4	1/2"	Non-locking	External	110/120 V, 50/60 Hz	7W	10" Hg - 150	35 - 150	54237-56
	K71FA00KS6K*41W2	1/2"	Non-locking	External	24 VDC	6W	10" Hg - 150	35 - 150	54237-56
	K71FA00KS6K*5	1/2"	Locking	External	110/120 V, 50/60 Hz	7W	10" Hg - 150	35 - 150	54237-56
	K71FA00KS6K*51W2	1/2"	Locking	External	24 VDC	6W	10" Hg - 150	35 - 150	54237-56

Replace \* with code below

**Connector Options Code**

V = Cable Grip    3 = 1/2" Conduit    1 = No Connector

Order example: K71FA00KS6K51W2 is a 5/2, 1/2", locking override, external pilot, 24 VDC, with cable grip connector.

**5/2 Double Solenoid**

Symbol	Model	Port Size (NPT)	Override	Pilot Supply	Voltage	Power	Operating Pressure	Pilot Pressure	Repair Kit
	K71DA00K*1K*1	1/4"	Non-locking	Internal	110/120 V, 50/60 Hz	7W	15 - 150	15 - 150	54237-56
	K71DA00K*1K*12W2	1/4"	Non-locking	Internal	24 VDC	6W	15 - 150	15 - 150	54237-56
	K71DA00K*2K*2	1/4"	Locking	Internal	110/120 V, 50/60 Hz	7W	15 - 150	15 - 150	54237-56
	K71DA00K*2K*22W2	1/4"	Locking	Internal	24 VDC	6W	15 - 150	15 - 150	54237-56
	K71DA00K*4K*4	1/4"	Non-locking	External	110/120 V, 50/60 Hz	7W	10" Hg - 150	15 - 150	54237-56
	K71DA00K*4K*42W2	1/4"	Non-locking	External	24 VDC	6W	10" Hg - 150	15 - 150	54237-56
	K71DA00K*5K*5	1/4"	Locking	External	110/120 V, 50/60 Hz	7W	10" Hg - 150	15 - 150	54237-56
	K71DA00K*5K*52W2	1/4"	Locking	External	24 VDC	6W	10" Hg - 150	15 - 150	54237-56
	K71EA00K*1K*1	3/8"	Non-locking	Internal	110/120 V, 50/60 Hz	7W	15 - 150	15 - 150	54237-56
	K71EA00K*1K*12W2	3/8"	Non-locking	Internal	24 VDC	6W	15 - 150	15 - 150	54237-56
	K71EA00K*2K*2	3/8"	Locking	Internal	110/120 V, 50/60 Hz	7W	15 - 150	15 - 150	54237-56
	K71EA00K*2K*22W2	3/8"	Locking	Internal	24 VDC	6W	15 - 150	15 - 150	54237-56
	K71EA00K*4K*4	3/8"	Non-locking	External	110/120 V, 50/60 Hz	7W	10" Hg - 150	15 - 150	54237-56
	K71EA00K*4K*42W2	3/8"	Non-locking	External	24 VDC	6W	10" Hg - 150	15 - 150	54237-56
	K71EA00K*5K*5	3/8"	Locking	External	110/120 V, 50/60 Hz	7W	10" Hg - 150	15 - 150	54237-56
	K71EA00K*5K*52W2	3/8"	Locking	External	24 VDC	6W	10" Hg - 150	15 - 150	54237-56
	K71FA00K*1K*1	1/2"	Non-locking	Internal	110/120 V, 50/60 Hz	7W	15 - 150	15 - 150	54237-56
	K71FA00K*1K*12W2	1/2"	Non-locking	Internal	24 VDC	6W	15 - 150	15 - 150	54237-56
	K71FA00K*2K*2	1/2"	Locking	Internal	110/120 V, 50/60 Hz	7W	15 - 150	15 - 150	54237-56
	K71FA00K*2K*22W2	1/2"	Locking	Internal	24 VDC	6W	15 - 150	15 - 150	54237-56
	K71FA00K*4K*4	1/2"	Non-locking	External	110/120 V, 50/60 Hz	7W	10" Hg - 150	15 - 150	54237-56
	K71FA00K*4K*42W2	1/2"	Non-locking	External	24 VDC	6W	10" Hg - 150	15 - 150	54237-56
	K71FA00K*5K*5	1/2"	Locking	External	110/120 V, 50/60 Hz	7W	10" Hg - 150	15 - 150	54237-56
	K71FA00K*5K*52W2	1/2"	Locking	External	24 VDC	6W	10" Hg - 150	15 - 150	54237-56

Replace \* with code below

**Connector Options Code**

- V = Cable Grip
- 3 = 1/2" Conduit
- 1 = No Connector

Order example: K71DA00K31K31 is a 5/2, 1/4", non-locking override, 110/120V, with 1/2" conduit connector.

**Note: Additional voltages, add or replace the 1W2 or 2W2 above with the code from table below in the desired part number**

Voltage	Single Solenoid	Double Solenoid
12 VDC	1W1	2W1
24V 50/60 Hz	1W4	2W4
220/240V, 50/60 Hz	1W6	2W6

- K41DA00KS6KV2 110/120V, 50/60Hz changed to a 12 VDC option
- K71DA00KS6KV21W1
- K71EA00KV2KV22W2 24 VDC changed to a 220/240V, 50/60 Hz option
- K71EA00KV2KV22W6
- K81FA00KV2KV22W2 24 VDC changed to a 24V, 50/60 Hz option
- K71FA00KV2KV22W4

**5/3 All Ports Blocked**

Symbol	Model	Port Size (NPT)	Override	Pilot Supply	Voltage	Power	Operating Pressure	Pilot Pressure	Repair Kit
	K81DA00K*8K*8	1/4"	Non-locking	Internal	110/120 V, 50/60 Hz	7W	45 - 150	45 - 150	54237-56
	K81DA00K*8K*82W2	1/4"	Non-locking	Internal	24 VDC	6W	45 - 150	45 - 150	54237-56
	K81DA00K*0K*0	1/4"	Locking	Internal	110/120 V, 50/60 Hz	7W	45 - 150	45 - 150	54237-56
	K81DA00K*0K*02W2	1/4"	Locking	Internal	24 VDC	6W	45 - 150	45 - 150	54237-56
	K81DA00K*9K*9	1/4"	Non-locking	External	110/120 V, 50/60 Hz	7W	10" Hg - 150	45 - 150	54237-56
	K81DA00K*9K*92W2	1/4"	Non-locking	External	24 VDC	6W	10" Hg - 150	45 - 150	54237-56
	K81DA00K*3K*3	1/4"	Locking	External	110/120 V, 50/60 Hz	7W	10" Hg - 150	45 - 150	54237-56
	K81DA00K*3K*32W2	1/4"	Locking	External	24 VDC	6W	10" Hg - 150	45 - 150	54237-56
	K81EA00K*8K*8	3/8"	Non-locking	Internal	110/120 V, 50/60 Hz	7W	45 - 150	45 - 150	54237-56
	K81EA00K*8K*82W2	3/8"	Non-locking	Internal	24 VDC	6W	45 - 150	45 - 150	54237-56
	K81EA00K*0K*0	3/8"	Locking	Internal	110/120 V, 50/60 Hz	7W	45 - 150	45 - 150	54237-56
	K81EA00K*0K*02W2	3/8"	Locking	Internal	24 VDC	6W	45 - 150	45 - 150	54237-56
	K81EA00K*9K*9	3/8"	Non-locking	External	110/120 V, 50/60 Hz	7W	10" Hg - 150	45 - 150	54237-56
	K81EA00K*9K*92W2	3/8"	Non-locking	External	24 VDC	6W	10" Hg - 150	45 - 150	54237-56
	K81EA00K*3K*3	3/8"	Locking	External	110/120 V, 50/60 Hz	7W	10" Hg - 150	45 - 150	54237-56
	K81EA00K*3K*32W2	3/8"	Locking	External	24 VDC	6W	10" Hg - 150	45 - 150	54237-56
	K81FA00K*8K*8	1/2"	Non-locking	Internal	110/120 V, 50/60 Hz	7W	45 - 150	45 - 150	54237-56
	K81FA00K*8K*82W2	1/2"	Non-locking	Internal	24 VDC	6W	45 - 150	45 - 150	54237-56
	K81FA00K*0K*0	1/2"	Locking	Internal	110/120 V, 50/60 Hz	7W	45 - 150	45 - 150	54237-56
	K81FA00K*0K*02W2	1/2"	Locking	Internal	24 VDC	6W	45 - 150	45 - 150	54237-56
	K81FA00K*9K*9	1/2"	Non-locking	External	110/120 V, 50/60 Hz	7W	10" Hg - 150	45 - 150	54237-56
	K81FA00K*9K*92W2	1/2"	Non-locking	External	24 VDC	6W	10" Hg - 150	45 - 150	54237-56
	K81FA00K*3K*3	1/2"	Locking	External	110/120 V, 50/60 Hz	7W	10" Hg - 150	45 - 150	54237-56
	K81FA00K*3K*32W2	1/2"	Locking	External	24 VDC	6W	10" Hg - 150	45 - 150	54237-56

Replace \* with code below

**Connector Options Code**

V = Cable Grip

3 = 1/2" Conduit

1 = No Connector

Order example: K81EA00K10K102W2 is a 5/3 APB, 3/8", locking override, 24 VDC, with no connector.

**Note: Additional voltages, add or replace the 1W2 or 2W2 above with the code from table below in the desired part number**

Voltage	Single Solenoid	Double Solenoid
12 VDC	1W1	2W1
24V 50/60 Hz	1W4	2W4
220/240V, 50/60 Hz	1W6	2W6

K41DA00KS6KV2 110/120V, 50/60Hz changed to a 12 VDC option

K71DA00KS6KV21W1

K71EA00KV2KV22W2 24 VDC changed to a 220/240V, 50/60 Hz option

K71EA00KV2KV22W6

K81FA00KV2KV22W2 24 VDC changed to a 24V, 50/60 Hz option

K71FA00KV2KV22W4

**5/3 Center Open to Exhaust**

Symbol	Model	Port Size (NPT)	Override	Pilot Supply	Voltage	Power	Operating Pressure	Pilot Pressure	Repair Kit
	K81DA06K*8K*8	1/4"	Non-locking	Internal	110/120 V, 50/60 Hz	7W	45 - 150	45 - 150	54237-58
	K81DA06K*8K*82W2	1/4"	Non-locking	Internal	24 VDC	6W	45 - 150	45 - 150	54237-58
	K81DA06K*0K*0	1/4"	Locking	Internal	110/120 V, 50/60 Hz	7W	45 - 150	45 - 150	54237-58
	K81DA06K*0K*02W2	1/4"	Locking	Internal	24 VDC	6W	45 - 150	45 - 150	54237-58
	K81DA06K*9K*9	1/4"	Non-locking	External	110/120 V, 50/60 Hz	7W	10" Hg - 150	45 - 150	54237-58
	K81DA06K*9K*92W2	1/4"	Non-locking	External	24 VDC	6W	10" Hg - 150	45 - 150	54237-58
	K81DA06K*3K*3	1/4"	Locking	External	110/120 V, 50/60 Hz	7W	10" Hg - 150	45 - 150	54237-58
	K81DA06K*3K*32W2	1/4"	Locking	External	24 VDC	6W	10" Hg - 150	45 - 150	54237-58
	K81EA06K*8K*8	3/8"	Non-locking	Internal	110/120 V, 50/60 Hz	7W	45 - 150	45 - 150	54237-58
	K81EA06K*8K*82W2	3/8"	Non-locking	Internal	24 VDC	6W	45 - 150	45 - 150	54237-58
	K81EA06K*0K*0	3/8"	Locking	Internal	110/120 V, 50/60 Hz	7W	45 - 150	45 - 150	54237-58
	K81EA06K*0K*02W2	3/8"	Locking	Internal	24 VDC	6W	45 - 150	45 - 150	54237-58
	K81EA06K*9K*9	3/8"	Non-locking	External	110/120 V, 50/60 Hz	7W	10" Hg - 150	45 - 150	54237-58
	K81EA06K*9K*92W2	3/8"	Non-locking	External	24 VDC	6W	10" Hg - 150	45 - 150	54237-58
	K81EA06K*3K*3	3/8"	Locking	External	110/120 V, 50/60 Hz	7W	10" Hg - 150	45 - 150	54237-58
	K81EA06K*3K*32W2	3/8"	Locking	External	24 VDC	6W	10" Hg - 150	45 - 150	54237-58
	K81FA06K*8K*8	1/2"	Non-locking	Internal	110/120 V, 50/60 Hz	7W	45 - 150	45 - 150	54237-58
	K81FA06K*8K*82W2	1/2"	Non-locking	Internal	24 VDC	6W	45 - 150	45 - 150	54237-58
	K81FA06K*0K*0	1/2"	Locking	Internal	110/120 V, 50/60 Hz	7W	45 - 150	45 - 150	54237-58
	K81FA06K*0K*02W2	1/2"	Locking	Internal	24 VDC	6W	45 - 150	45 - 150	54237-58
	K81FA06K*9K*9	1/2"	Non-locking	External	110/120 V, 50/60 Hz	7W	10" Hg - 150	45 - 150	54237-58
	K81FA06K*9K*92W2	1/2"	Non-locking	External	24 VDC	6W	10" Hg - 150	45 - 150	54237-58
	K81FA06K*3K*3	1/2"	Locking	External	110/120 V, 50/60 Hz	7W	10" Hg - 150	45 - 150	54237-58
	K81FA06K*3K*32W2	1/2"	Locking	External	24 VDC	6W	10" Hg - 150	45 - 150	54237-58

Replace \* with code below  
**Connector Options Code**

- V = Cable Grip
- 3 = 1/2" Conduit
- 1 = No Connector

Order example: K81FA06KV8KV8 is a 5/3 COE, 1/2", non-locking override, 110/120V, with cable grip connector.

**Note: Additional voltages, add or replace the 1W2 or 2W2 above with the code from table below in the desired part number**

Voltage	Single Solenoid	Double Solenoid
12 VDC	1W1	2W1
24V 50/60 Hz	1W4	2W4
220/240V, 50/60 Hz	1W6	2W6

K41DA00KS6KV2 110/120V, 50/60Hz changed to a 12 VDC option  
 K71DA00KS6KV21W1  
 K71EA00KV2KV22W2 24 VDC changed to a 220/240V, 50/60 Hz option  
 K71EA00KV2KV22W6  
 K81FA00KV2KV22W2 24 VDC changed to a 24V, 50/60 Hz option  
 K71FA00KV2KV22W4

**5/3 Center Open to Pressure**

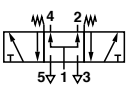
Symbol	Model	Port Size (NPT)	Override	Pilot Supply	Voltage	Power	Operating Pressure	Pilot Pressure	Repair Kit
	K81DA05K*8K*8	1/4"	Non-locking	Internal	110/120 V, 50/60 Hz	7W	45 - 150	45 - 150	54237-57
	K81DA05K*8K*82W2	1/4"	Non-locking	Internal	24 VDC	6W	45 - 150	45 - 150	54237-57
	K81DA05K*0K*0	1/4"	Locking	Internal	110/120 V, 50/60 Hz	7W	45 - 150	45 - 150	54237-57
	K81DA05K*0K*02W2	1/4"	Locking	Internal	24 VDC	6W	45 - 150	45 - 150	54237-57
	K81DA05K*9K*9	1/4"	Non-locking	External	110/120 V, 50/60 Hz	7W	10" Hg - 150	45 - 150	54237-57
	K81DA05K*9K*92W2	1/4"	Non-locking	External	24 VDC	6W	10" Hg - 150	45 - 150	54237-57
	K81DA05K*3K*3	1/4"	Locking	External	110/120 V, 50/60 Hz	7W	10" Hg - 150	45 - 150	54237-57
	K81DA05K*3K*32W2	1/4"	Locking	External	24 VDC	6W	10" Hg - 150	45 - 150	54237-57
	K81EA05K*8K*8	3/8"	Non-locking	Internal	110/120 V, 50/60 Hz	7W	45 - 150	45 - 150	54237-57
	K81EA05K*8K*82W2	3/8"	Non-locking	Internal	24 VDC	6W	45 - 150	45 - 150	54237-57
	K81EA05K*0K*0	3/8"	Locking	Internal	110/120 V, 50/60 Hz	7W	45 - 150	45 - 150	54237-57
	K81EA05K*0K*02W2	3/8"	Locking	Internal	24 VDC	6W	45 - 150	45 - 150	54237-57
	K81EA05K*9K*9	3/8"	Non-locking	External	110/120 V, 50/60 Hz	7W	10" Hg - 150	45 - 150	54237-57
	K81EA05K*9K*92W2	3/8"	Non-locking	External	24 VDC	6W	10" Hg - 150	45 - 150	54237-57
	K81EA05K*3K*3	3/8"	Locking	External	110/120 V, 50/60 Hz	7W	10" Hg - 150	45 - 150	54237-57
	K81EA05K*3K*32W2	3/8"	Locking	External	24 VDC	6W	10" Hg - 150	45 - 150	54237-57
	K81FA05K*8K*8	1/2"	Non-locking	Internal	110/120 V, 50/60 Hz	7W	45 - 150	45 - 150	54237-57
	K81FA05K*8K*82W2	1/2"	Non-locking	Internal	24 VDC	6W	45 - 150	45 - 150	54237-57
	K81FA05K*0K*0	1/2"	Locking	Internal	110/120 V, 50/60 Hz	7W	45 - 150	45 - 150	54237-57
	K81FA05K*0K*02W2	1/2"	Locking	Internal	24 VDC	6W	45 - 150	45 - 150	54237-57
	K81FA05K*9K*9	1/2"	Non-locking	External	110/120 V, 50/60 Hz	7W	10" Hg - 150	45 - 150	54237-57
	K81FA05K*9K*92W2	1/2"	Non-locking	External	24 VDC	6W	10" Hg - 150	45 - 150	54237-57
	K81FA05K*3K*3	1/2"	Locking	External	110/120 V, 50/60 Hz	7W	10" Hg - 150	45 - 150	54237-57
	K81FA05K*3K*32W2	1/2"	Locking	External	24 VDC	6W	10" Hg - 150	45 - 150	54237-57

Replace \* with code below

**Connector Options Code**

V = Cable Grip

3 = 1/2" Conduit

1 = No Connector

Order example: K81DA05KV8KV8 is a 5/3 APB, 1/4", non-locking override, 110/120 VAC, with cable grip connector.

**Note: Additional voltages, add or replace the 1W2 or 2W2 above with the code from table below in the desired part number**

Voltage	Single Solenoid	Double Solenoid
12 VDC	1W1	2W1
24V 50/60 Hz	1W4	2W4
220/240V, 50/60 Hz	1W6	2W6

K41DA00KS6KV2 110/120V, 50/60Hz changed to a 12 VDC option

K71DA00KS6KV21W1

K71EA00KV2KV22W2 24 VDC changed to a 220/240V, 50/60 Hz option

K71EA00KV2KV22W6

K81FA00KV2KV22W2 24 VDC changed to a 24V, 50/60 Hz option

K71FA00KV2KV22W4

**3/2 Solenoid/Spring return, Normally Open, with Cable Grip connector**

Symbol	Model	Port Size ISO G	Override	Pilot Supply	Voltage	Operating Pressure	Pilot Pressure	Repair Kit
	K41DG00KVCKS6	1/4"	Locking	Internal	120 VAC 60 Hz 7W	35 - 150	35 - 150	54237-59
	K41DG00KVCKS61W2	1/4"	Locking	Internal	24 VDC 6W	35 - 150	35 - 150	54237-59
	K41EG00KVCKS6	3/8"	Locking	Internal	120 VAC 60 Hz 7W	35 - 150	35 - 150	54237-59
	K41EG00KVCKS61W2	3/8"	Locking	Internal	24 VDC 6W	35 - 150	35 - 150	54237-59

**3/2 Solenoid/Spring return, Normally Closed, with Cable Grip connector**

Symbol	Model	Port Size ISO G	Override	Pilot Supply	Voltage	Operating Pressure	Pilot Pressure	Repair Kit
	K41DG00KS6KVC	1/4"	Locking	Internal	120 VAC 60 Hz 7W	35 - 150	35 - 150	54237-59
	K41DG00KS6KVC1W2	1/4"	Locking	Internal	24 VDC 6W	35 - 150	35 - 150	54237-59
	K41EG00KS6KVC	3/8"	Locking	Internal	120 VAC 60 Hz 7W	35 - 150	35 - 150	54237-59
	K41EG00KS6KVC1W2	3/8"	Locking	Internal	24 VDC 6W	35 - 150	35 - 150	54237-59

**3/2 Solenoid/Solenoid, with Cable Grip connector**

Symbol	Model	Port Size ISO G	Override	Pilot Supply	Voltage	Operating Pressure	Pilot Pressure	Repair Kit
	K41DG00KVCKVC	1/4"	Locking	Internal	120 VAC 60 Hz 7W	35 - 150	35 - 150	54237-59
	K41DG00KVCKVC2W2	1/4"	Locking	Internal	24 VDC 6W	35 - 150	35 - 150	54237-59
	K41EG00KVCKVC	3/8"	Locking	Internal	120 VAC 60 Hz 7W	35 - 150	35 - 150	54237-59
	K41EG00KVCKVC2W2	3/8"	Locking	Internal	24 VDC 6W	35 - 150	35 - 150	54237-59

**5/2 Solenoid /Spring Return, with Cable Grip connector**

Symbol	Model	Port Size ISO G	Override	Pilot Supply	Voltage	Operating Pressure	Pilot Pressure	Repair Kit
	K71DG00KS6KVC	1/4"	Locking	Internal	120 VAC 60 Hz 7W	35 - 150	35 - 150	54237-56
	K71DG00KS6KVC1W2	1/4"	Locking	Internal	24 VDC 6W	35 - 150	35 - 150	54237-56
	K71EG00KS6KVC	3/8"	Locking	Internal	120 VAC 60 Hz 7W	35 - 150	35 - 150	54237-56
	K71EG00KS6KVC1W2	3/8"	Locking	Internal	24 VDC 6W	35 - 150	35 - 150	54237-56
	K71FG00KS6KVC	1/2"	Locking	Internal	120 VAC 60 Hz 7W	35 - 150	35 - 150	54237-56
	K71FG00KS6KVC1W2	1/2"	Locking	Internal	24 VDC 6W	35 - 150	35 - 150	54237-56

**5/2 Double Solenoid, with Cable Grip connector**

Symbol	Model	Port Size ISO G	Override	Pilot Supply	Voltage	Operating Pressure	Pilot Pressure	Repair Kit
	VAL- 145 Image to come from Gary	1/4"	Locking	Internal	120 VAC 60 Hz 7W	15 - 150	15 - 150	54237-56
	K71DG00KVCKVC	1/4"	Locking	Internal	120 VAC 60 Hz 7W	15 - 150	15 - 150	54237-56
	K71DG00KVCKVC2W2	1/4"	Locking	Internal	24 VDC 6W	15 - 150	15 - 150	54237-56
	K71EG00KVCKVC	3/8"	Locking	Internal	120 VAC 60 Hz 7W	15 - 150	15 - 150	54237-56
	K71EG00KVCKVC2W2	3/8"	Locking	Internal	24 VDC 6W	15 - 150	15 - 150	54237-56
	K71FG00KVCKVC	1/2"	Locking	Internal	120 VAC 60 Hz 7W	15 - 150	15 - 150	54237-56
K71FG00KVCKVC2W2	1/2"	Locking	Internal	24 VDC 6W	15 - 150	15 - 150	54237-56	

**5/3 All Ports Blocked**

Symbol	Model	Port Size ISO G	Override	Pilot Supply	Voltage	Operating Pressure	Pilot Pressure	Repair Kit
	K81DG00KVAKVA	1/4"	Locking	Internal	120 VAC 60 Hz 7W	45 - 150	45 - 150	54237-56
	K81DG00KVAKVA2W2	1/4"	Locking	Internal	24 VDC 6W	45 - 150	45 - 150	54237-56
	K81EG00KVAKVA	3/8"	Locking	Internal	120 VAC 60 Hz 7W	45 - 150	45 - 150	54237-56
	K81EG00KVAKVA2W2	3/8"	Locking	Internal	24 VDC 6W	45 - 150	45 - 150	54237-56
	K81FG00KVAKVA	1/2"	Locking	Internal	120 VAC 60 Hz 7W	45 - 150	45 - 150	54237-56
	K81FG00KVAKVA2W2	1/2"	Locking	Internal	24 VDC 6W	45 - 150	45 - 150	54237-56

**5/3 Center Open to Exhaust**

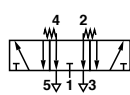
Symbol	Model	Port Size ISO G	Override	Pilot Supply	Voltage	Operating Pressure	Pilot Pressure	Repair Kit
	K81DG06KVAKVA	1/4"	Locking	Internal	120 VAC 60 Hz 7W	45 - 150	45 - 150	54237-58
	K81DG06KVAKVA2W2	1/4"	Locking	Internal	24 VDC 6W	45 - 150	45 - 150	54237-58
	K81EG06KVAKVA	3/8"	Locking	Internal	120 VAC 60 Hz 7W	45 - 150	45 - 150	54237-58
	K81EG06KVAKVA2W2	3/8"	Locking	Internal	24 VDC 6W	45 - 150	45 - 150	54237-58
	K81FG06KVAKVA	1/2"	Locking	Internal	120 VAC 60 Hz 7W	45 - 150	45 - 150	54237-58
	K81FG06KVAKVA2W2	1/2"	Locking	Internal	24 VDC 6W	45 - 150	45 - 150	54237-58

**5/3 Center Open to Pressure**

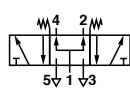
Symbol	Model	Port Size ISO G	Override	Pilot Supply	Voltage	Operating Pressure	Pilot Pressure	Repair Kit
	K81DG05KVAKVA	1/4"	Locking	Internal	120 VAC 60 Hz 7W	45 - 150	45 - 150	54237-57
	K81DG05KVAKVA2W2	1/4"	Locking	Internal	24 VDC 6W	45 - 150	45 - 150	54237-57
	K81EG05KVAKVA	3/8"	Locking	Internal	120 VAC 60 Hz 7W	45 - 150	45 - 150	54237-57
	K81EG05KVAKVA2W2	3/8"	Locking	Internal	24 VDC 6W	45 - 150	45 - 150	54237-57
	K81FG05KVAKVA	1/2"	Locking	Internal	120 VAC 60 Hz 7W	45 - 150	45 - 150	54237-57
	K81FG05KVAKVA2W2	1/2"	Locking	Internal	24 VDC 6W	45 - 150	45 - 150	54237-57

**3/2 Solenoid/Spring return Normally Open**

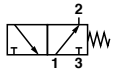
Symbol	Model	Port Size (NPT)	Override	Pilot Supply	Voltage	Power	Operating Pressure	Pilot Pressure	Repair Kit
	K41DA00KX1KS6	1/4"	Non-locking	Internal	110/120 V, 50/60 Hz	12W	35 - 150	35 - 150	54237-59
	K41DA00KX1KS61ND	1/4"	Non-locking	Internal	24 VDC	12W	35 - 150	35 - 150	54237-59
	K41DA00KX2KS6	1/4"	Locking	Internal	110/120 V, 50/60 Hz	12W	35 - 150	35 - 150	54237-59
	K41DA00KX2KS61ND	1/4"	Locking	Internal	24 VDC	12W	35 - 150	35 - 150	54237-59
	K41EA00KX1KS6	3/8"	Non-locking	Internal	110/120 V, 50/60 Hz	12W	35 - 150	35 - 150	54237-59
	K41EA00KX1KS61ND	3/8"	Non-locking	Internal	24 VDC	12W	35 - 150	35 - 150	54237-59
	K41EA00KX2KS6	3/8"	Locking	Internal	110/120 V, 50/60 Hz	12W	35 - 150	35 - 150	54237-59
	K41EA00KX2KS61ND	3/8"	Locking	Internal	24 VDC	12W	35 - 150	35 - 150	54237-59

**3/2 Solenoid/Spring return Normally Closed**

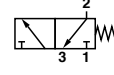
Symbol	Model	Port Size (NPT)	Override	Pilot Supply	Voltage	Power	Operating Pressure	Pilot Pressure	Repair Kit
	K41DA00KS6KX1	1/4"	Non-locking	Internal	110/120 V, 50/60 Hz	12W	35 - 150	35 - 150	54237-59
	K41DA00KS6KX11ND	1/4"	Non-locking	Internal	24 VDC	12W	35 - 150	35 - 150	54237-59
	K41DA00KS6KX2	1/4"	Locking	Internal	110/120 V, 50/60 Hz	12W	35 - 150	35 - 150	54237-59
	K41DA00KS6KX21ND	1/4"	Locking	Internal	24 VDC	12W	35 - 150	35 - 150	54237-59
	K41EA00KS6KX1	3/8"	Non-locking	Internal	110/120 V, 50/60 Hz	12W	35 - 150	35 - 150	54237-59
	K41EA00KS6KX11ND	3/8"	Non-locking	Internal	24 VDC	12W	35 - 150	35 - 150	54237-59
	K41EA00KS6KX2	3/8"	Locking	Internal	110/120 V, 50/60 Hz	12W	35 - 150	35 - 150	54237-59
	K41EA00KS6KX21ND	3/8"	Locking	Internal	24 VDC	12W	35 - 150	35 - 150	54237-59

**3/2 Solenoid/Solenoid**

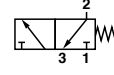
Symbol	Model	Port Size (NPT)	Override	Pilot Supply	Voltage	Power	Operating Pressure	Pilot Pressure	Repair Kit
	K41DA00KX1KX1	1/4"	Non-locking	Internal	110/120 V, 50/60 Hz	12W	35 - 150	35 - 150	54237-59
	K41DA00KX1KX12ND	1/4"	Non-locking	Internal	24 VDC	12W	35 - 150	35 - 150	54237-59
	K41DA00KX2KX2	1/4"	Locking	Internal	110/120 V, 50/60 Hz	12W	35 - 150	35 - 150	54237-59
	K41DA00KX2KX22ND	1/4"	Locking	Internal	24 VDC	12W	35 - 150	35 - 150	54237-59
	K41EA00KX1KX1	3/8"	Non-locking	Internal	110/120 V, 50/60 Hz	12W	35 - 150	35 - 150	54237-59
	K41EA00KX1KX12ND	3/8"	Non-locking	Internal	24 VDC	12W	35 - 150	35 - 150	54237-59
	K41EA00KX2KX2	3/8"	Locking	Internal	110/120 V, 50/60 Hz	12W	35 - 150	35 - 150	54237-59
	K41EA00KX2KX22ND	3/8"	Locking	Internal	24 VDC	12W	35 - 150	35 - 150	54237-59



**5/2 Solenoid /Spring Return**

Symbol	Model	Port Size (NPT)	Override	Pilot Supply	Voltage	Power	Operating Pressure	Pilot Pressure	Repair Kit
	K71DA00KS6KX1	1/4"	Non-locking	Internal	110/120 V, 50/60 Hz	12W	35 - 150	35 - 150	54237-56
	K71DA00KS6KX11ND	1/4"	Non-locking	Internal	24 VDC	12W	35 - 150	35 - 150	54237-56
	K71DA00KS6KX2	1/4"	Locking	Internal	110/120 V, 50/60 Hz	12W	35 - 150	35 - 150	54237-56
	K71DA00KS6KX21ND	1/4"	Locking	Internal	24 VDC	12W	35 - 150	35 - 150	54237-56
	K71EA00KS6KX1	3/8"	Non-locking	Internal	110/120 V, 50/60 Hz	12W	35 - 150	35 - 150	54237-56
	K71EA00KS6KX11ND	3/8"	Non-locking	Internal	24 VDC	12W	35 - 150	35 - 150	54237-56
	K71EA00KS6KX2	3/8"	Locking	Internal	110/120 V, 50/60 Hz	12W	35 - 150	35 - 150	54237-56
	K71EA00KS6KX21ND	3/8"	Locking	Internal	24 VDC	12W	35 - 150	35 - 150	54237-56
	K71FA00KS6KX1	1/2"	Non-locking	Internal	110/120 V, 50/60 Hz	12W	35 - 150	35 - 150	54237-56
	K71FA00KS6KX11ND	1/2"	Non-locking	Internal	24 VDC	12W	35 - 150	35 - 150	54237-56
	K71FA00KS6KX2	1/2"	Locking	Internal	110/120 V, 50/60 Hz	12W	35 - 150	35 - 150	54237-56
	K71FA00KS6KX21ND	1/2"	Locking	Internal	24 VDC	12W	35 - 150	35 - 150	54237-56

**5/2 Double Solenoid**

Symbol	Model	Port Size (NPT)	Override	Pilot Supply	Voltage	Power	Operating Pressure	Pilot Pressure	Repair Kit
	K71DA00KX1KX1	1/4"	Non-locking	Internal	110/120 V, 50/60 Hz	12W	15 - 150	15 - 150	54237-56
	K71DA00KX1KX12ND	1/4"	Non-locking	Internal	24 VDC	12W	15 - 150	15 - 150	54237-56
	K71DA00KX2KX2	1/4"	Locking	Internal	110/120 V, 50/60 Hz	12W	15 - 150	15 - 150	54237-56
	K71DA00KX2KX22ND	1/4"	Locking	Internal	24 VDC	12W	15 - 150	15 - 150	54237-56
	K71EA00KX1KX1	3/8"	Non-locking	Internal	110/120 V, 50/60 Hz	12W	15 - 150	15 - 150	54237-56
	K71EA00KX1KX12ND	3/8"	Non-locking	Internal	24 VDC	12W	15 - 150	15 - 150	54237-56
	K71EA00KX2KX2	3/8"	Locking	Internal	110/120 V, 50/60 Hz	12W	15 - 150	15 - 150	54237-56
	K71EA00KX2KX22ND	3/8"	Locking	Internal	24 VDC	12W	15 - 150	15 - 150	54237-56
	K71FA00KX1KX1	1/2"	Non-locking	Internal	110/120 V, 50/60 Hz	12W	15 - 150	15 - 150	54237-56
	K71FA00KX1KX12ND	1/2"	Non-locking	Internal	24 VDC	12W	15 - 150	15 - 150	54237-56
	K71FA00KX2KX2	1/2"	Locking	Internal	110/120 V, 50/60 Hz	12W	15 - 150	15 - 150	54237-56
	K71FA00KX2KX22ND	1/2"	Locking	Internal	24 VDC	12W	15 - 150	15 - 150	54237-56

**5/3 All Ports Blocked**

Symbol	Model	Port Size (NPT)	Override	Pilot Supply	Voltage	Power	Operating Pressure	Pilot Pressure	Repair Kit
	K81DA00KX8KX8	1/4"	Non-locking	Internal	110/120 V, 50/60 Hz	12W	45 - 150	45 - 150	54237-56
	K81DA00KX8KX82ND	1/4"	Non-locking	Internal	24 VDC	12W	45 - 150	45 - 150	54237-56
	K81EA00KX8KX8	3/8"	Non-locking	Internal	110/120 V, 50/60 Hz	12W	45 - 150	45 - 150	54237-56
	K81EA00KX8KX82ND	3/8"	Non-locking	Internal	24 VDC	12W	45 - 150	45 - 150	54237-56
	K81FA00KX8KX8	1/2"	Non-locking	Internal	110/120 V, 50/60 Hz	12W	45 - 150	45 - 150	54237-56
	K81FA00KX8KX82ND	1/2"	Non-locking	Internal	24 VDC	12W	45 - 150	45 - 150	54237-56

**5/3 Center Open to Exhaust**

Symbol	Model	Port Size (NPT)	Override	Pilot Supply	Voltage	Power	Operating Pressure	Pilot Pressure	Repair Kit
	K81DA06KX8KX8	1/4"	Non-locking	Internal	110/120 V, 50/60 Hz	12W	45 - 150	45 - 150	54237-58
	K81DA06KX8KX82ND	1/4"	Non-locking	Internal	24 VDC	12W	45 - 150	45 - 150	54237-58
	K81EA06KX8KX8	3/8"	Non-locking	Internal	110/120 V, 50/60 Hz	12W	45 - 150	45 - 150	54237-58
	K81EA06KX8KX82ND	3/8"	Non-locking	Internal	24 VDC	12W	45 - 150	45 - 150	54237-58
	K81FA06KX8KX8	1/2"	Non-locking	Internal	110/120 V, 50/60 Hz	12W	45 - 150	45 - 150	54237-58
	K81FA06KX8KX82ND	1/2"	Non-locking	Internal	24 VDC	12W	45 - 150	45 - 150	54237-58

**5/3 Center Open to Pressure**

Symbol	Model	Port Size (NPT)	Override	Pilot Supply	Voltage	Power	Operating Pressure	Pilot Pressure	Repair Kit
	K81DA05KX8KX8	1/4"	Non-locking	Internal	110/120 V, 50/60 Hz	12W	45 - 150	45 - 150	54237-57
	K81DA05KX8KX82ND	1/4"	Non-locking	Internal	24 VDC	12W	45 - 150	45 - 150	54237-57
	K81EA05KX8KX8	3/8"	Non-locking	Internal	110/120 V, 50/60 Hz	12W	45 - 150	45 - 150	54237-57
	K81EA05KX8KX82ND	3/8"	Non-locking	Internal	24 VDC	12W	45 - 150	45 - 150	54237-57
	K81FA05KX8KX8	1/2"	Non-locking	Internal	110/120 V, 50/60 Hz	12W	45 - 150	45 - 150	54237-57
	K81FA05KX8KX82ND	1/2"	Non-locking	Internal	24 VDC	12W	45 - 150	45 - 150	54237-57

**KUx/KVx Series (cable grip)**  
**K2x/K3x Series (conduit)**  
**K4x/K5x Series (molded cord)**

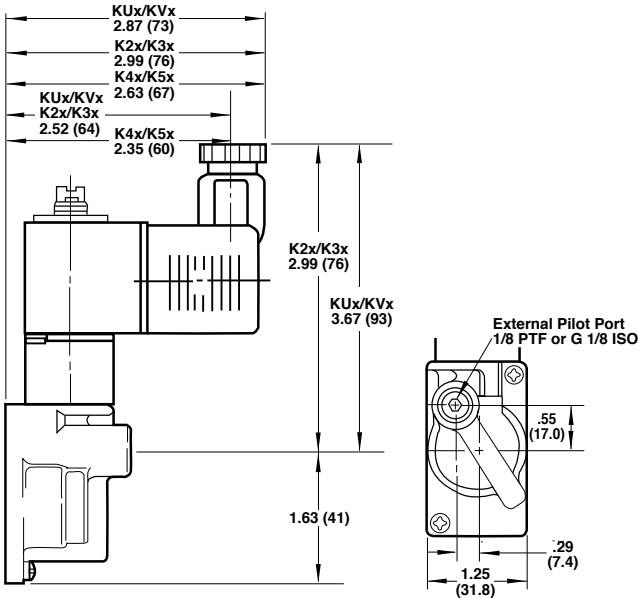

**KX Series hazardous location**

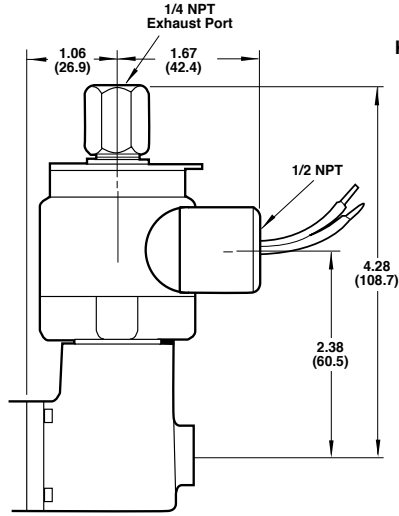

**Kx Series – Hazardous Location**

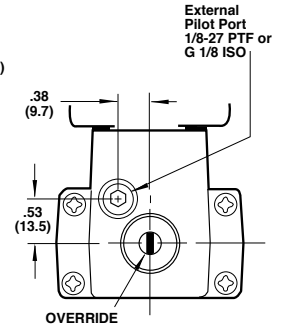

**Inline Bodies**

**3-WAY – 1/4" & 3/8" PORTS**  
**K41**

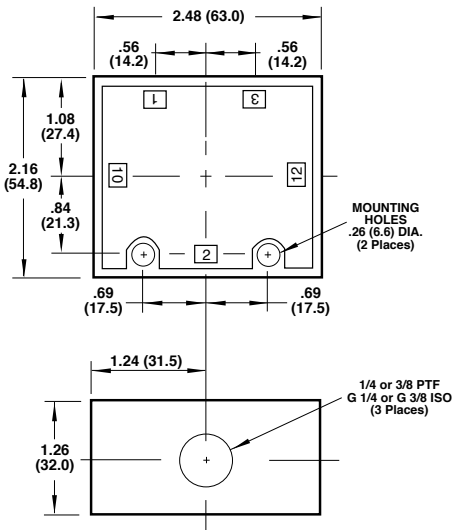

**4-WAY – 1/4", 3/8", 1/2" PORTS**  
**K71 or K81**

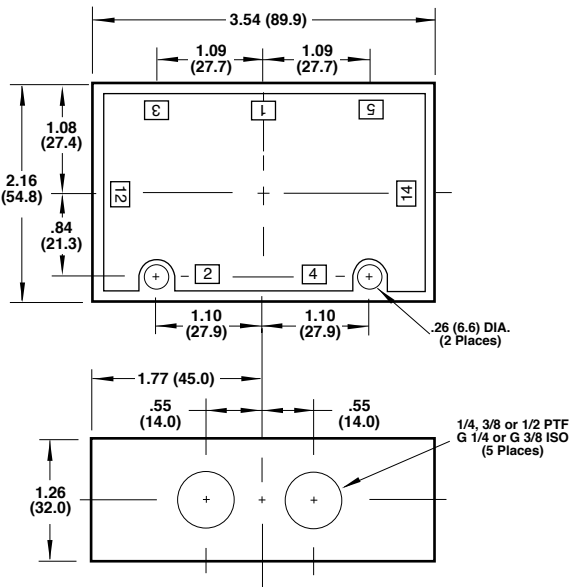

**KS6 Spring Return**

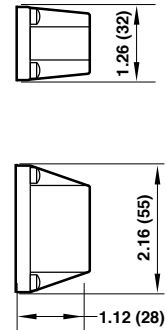

Dimensions in inches (mm)

**Standard watt solenoid for 2-position valve, internally piloted**

Non-locking NPT Thread	Locking NPT Thread	Locking ISO G Thread	Voltage	Replacement Coil	Connector	Replacement Connector
K11	K12	None	110/120 V, 50/60 Hz	54452-01	No connector	None
K111W1	K121W1	None	12 VDC	54452-02	No connector	None
K111W2	K121W2	None	24 VDC	54452-03	No connector	None
K111W4	K121W4	None	24 V, 50/60 Hz	54452-05	No connector	None
K111W6	K121W6	None	220/240 V, 50/60 Hz	54452-07	No connector	None
K31	K32	None	110/120 V, 50/60 Hz	54452-01	1/2" Conduit connector	54934-05
K311W1	K321W1	None	12 VDC	54452-02	1/2" Conduit connector	54934-05
K311W2	K321W2	None	24 VDC	54452-03	1/2" Conduit connector	54934-05
K311W4	K321W4	None	24 V, 50/60 Hz	54452-05	1/2" Conduit connector	54934-05
K311W6	K321W6	None	220/240 V, 50/60 Hz	54452-07	1/2" Conduit connector	54934-05
KV1	KV2	KVC	110/120 V, 50/60 Hz	54452-01	Cable grip connector	54934-01
KV11W1	KV21W1	KVC1W1	12 VDC	54452-02	Cable grip connector	54934-01
KV11W2	KV21W2	KVC1W2	24 VDC	54452-03	Cable grip connector	54934-01
KV11W4	KV21W4	KVC1W4	24 V, 50/60 Hz	54452-05	Cable grip connector	54934-01
KV11W6	KV21W6	KVC1W6	220/240 V, 50/60 Hz	54452-07	Cable grip connector	54934-01

**Standard watt solenoid for 3-position valve, internally piloted**

Non-locking NPT Thread	Locking NPT Thread	Locking ISO G Thread	Voltage	Replacement Coil	Connector	Replacement Connector
K18	K10	None	110/120 V, 50/60 Hz	54452-01	No connector	None
K181W1	K101W1	None	12 VDC	54452-02	No connector	None
K181W2	K101W2	None	24 VDC	54452-03	No connector	None
K181W4	K101W4	None	24 V, 50/60 Hz	54452-05	No connector	None
K181W6	K101W6	None	220/240 V, 50/60 Hz	54452-07	No connector	None
K38	K30	None	110/120 V, 50/60 Hz	54452-01	1/2" Conduit connector	54934-05
K381W1	K301W1	None	12 VDC	54452-02	1/2" Conduit connector	54934-05
K381W2	K301W2	None	24 VDC	54452-03	1/2" Conduit connector	54934-05
K381W4	K301W4	None	24 V, 50/60 Hz	54452-05	1/2" Conduit connector	54934-05
K381W6	K301W6	None	220/240 V, 50/60 Hz	54452-07	1/2" Conduit connector	54934-05
KV8	KV0	KVA	110/120 V, 50/60 Hz	54452-01	Cable grip connector	54934-01
KV81W1	KV01W1	KVA1W1	12 VDC	54452-02	Cable grip connector	54934-01
KV81W2	KV01W2	KVA1W2	24 VDC	54452-03	Cable grip connector	54934-01
KV81W4	KV01W4	KVA1W4	24 V, 50/60 Hz	54452-05	Cable grip connector	54934-01
KV81W6	KV01W6	KVA1W6	220/240 V, 50/60 Hz	54452-07	Cable grip connector	54934-01

**Standard watt solenoid for 2-position valve, externally piloted**

Non-locking NPT Thread	Locking NPT Thread	Voltage	Replacement Coil	Connector	Replacement Connector
K14	K15	110/120 V, 50/60 Hz	54452-01	No connector	None
K141W1	K151W1	12 VDC	54452-02	No connector	None
K141W2	K151W2	24 VDC	54452-03	No connector	None
K141W4	K151W4	24 V, 50/60 Hz	54452-05	No connector	None
K141W6	K151W6	220/240 V, 50/60 Hz	54452-07	No connector	None
K34	K35	110/120 V, 50/60 Hz	54452-01	1/2" Conduit connector	54934-05
K341W1	K351W1	12 VDC	54452-02	1/2" Conduit connector	54934-05
K341W2	K351W2	24 VDC	54452-03	1/2" Conduit connector	54934-05
K341W4	K351W4	24 V, 50/60 Hz	54452-05	1/2" Conduit connector	54934-05
K341W6	K351W6	220/240 V, 50/60 Hz	54452-07	1/2" Conduit connector	54934-05
KV4	KV5	110/120 V, 50/60 Hz	54452-01	Cable grip connector	54934-01
KV41W1	KV51W1	12 VDC	54452-02	Cable grip connector	54934-01
KV41W2	KV51W2	24 VDC	54452-03	Cable grip connector	54934-01
KV41W4	KV51W4	24 V, 50/60 Hz	54452-05	Cable grip connector	54934-01
KV41W6	KV51W6	220/240 V, 50/60 Hz	54452-07	Cable grip connector	54934-01

**Standard watt solenoid for 3-position valve, externally piloted**

Non-locking NPT Thread	Locking NPT Thread	Voltage	Replacement Coil	Connector	Replacement Connector
K19	K13	110/120 V, 50/60 Hz	54452-01	No connector	None
K191W1	K131W1	12 VDC	54452-02	No connector	None
K191W2	K131W2	24 VDC	54452-03	No connector	None
K191W4	K131W4	24 V, 50/60 Hz	54452-05	No connector	None
K191W6	K131W6	220/240 V, 50/60 Hz	54452-07	No connector	None
K39	K33	110/120 V, 50/60 Hz	54452-01	1/2" Conduit connector	54934-05
K391W1	K331W1	12 VDC	54452-02	1/2" Conduit connector	54934-05
K391W2	K331W2	24 VDC	54452-03	1/2" Conduit connector	54934-05
K391W4	K331W4	24 V, 50/60 Hz	54452-05	1/2" Conduit connector	54934-05
K391W6	K331W6	220/240 V, 50/60 Hz	54452-07	1/2" Conduit connector	54934-05
KV9	KV3	110/120 V, 50/60 Hz	54452-01	Cable grip connector	54934-01
KV91W1	KV31W1	12 VDC	54452-02	Cable grip connector	54934-01
KV91W2	KV31W2	24 VDC	54452-03	Cable grip connector	54934-01
KV91W4	KV31W4	24 V, 50/60 Hz	54452-05	Cable grip connector	54934-01
KV91W6	KV31W6	220/240 V, 50/60 Hz	54452-07	Cable grip connector	54934-01

**Low watt solenoid for 2-position valve, internally piloted**

Non-locking NPT Thread	Locking NPT Thread	Voltage	Replacement Coil	Connector	Replacement Connector
K01	K02	24 VDC	54469-02	No Connector	None
K011WF	K021WF	12 VDC	54469-01	No Connector	None
KU1	KU2	24 VDC	54469-02	Cable Grip	54934-01
KU11WF	KU21WF	12 VDC	54469-01	Cable Grip	54934-01

**Low watt solenoid for 2-position valve, externally piloted**

Non-locking NPT Thread	Locking NPT Thread	Voltage	Replacement Coil	Connector	Replacement Connector
K04	K05	24 VDC	54469-02	No Connector	None
K041WF	K051WF	12 VDC	54469-01	No Connector	None
KU4	KU5	24 VDC	54469-02	Cable Grip	54934-01
KU41WF	KU51WF	12 VDC	54469-01	Cable Grip	54934-01

**Low watt solenoid for 3-position valve, internally piloted**

Non-locking NPT Thread	Locking NPT Thread	Voltage	Replacement Coil	Connector	Replacement Connector
K08	K00	24 VDC	54469-02	No Connector	None
K081WF	K001WF	12 VDC	54469-01	No Connector	None
KU8	KU0	24 VDC	54469-02	Cable Grip	54934-01
KU81WF	KU01WF	12 VDC	54469-01	Cable Grip	54934-01

### Low watt solenoid for 3-position valve, externally piloted

Non-locking NPT Thread	Locking NPT Thread	Voltage	Replacement Coil	Connector	Replacement Connector
K09	K03	24 VDC	54469-02	No Connector	None
K091WF	K031WF	12 VDC	54469-01	No Connector	None
KU9	KU3	24 VDC	54469-02	Cable Grip	54934-01
KU91WF	KU31WF	12 VDC	54469-01	Cable Grip	54934-01

### Hazardous solenoid for 2-position valve, internally piloted

Non-locking NPT Thread	Locking NPT Thread	Voltage	Replacement Coil	Connector	Replacement Connector
KX1	KX2	120 V, 60 Hz	None	1/2" Conduit connector	None
KX11ND	KX21ND	24 VDC	None	1/2" Conduit connector	None

### Low watt solenoid for 3-position valve, internally piloted

Non-locking NPT Thread	Voltage	Replacement Coil	Connector	Replacement Connector
KX8	120 V, 60 Hz	None	1/2" Conduit connector	None
KX81ND	24 VDC	None	1/2" Conduit connector	None

### Replacement Valve Body

NPT Thread	ISOG Thread	Function	Port Size	Replacement Spool
K41DA00	K41DG00	3-ported / 2 position	1/4"	54237-59
K41ED00	K41ED00	3-ported / 2 position	3/8"	54237-59
K71DA00	K71DG00	5-ported / 2 position	1/4"	54237-56
K71EA00	K71EG00	5-ported / 2 position	3/8"	54237-56
K71FA00	K71FG00	5-ported / 2 position	1/2"	54237-56
K81DA00	K81DG00	5-ported / 3 position APB	1/4"	54237-56
K81EA00	K81EG00	5-ported / 3 position APB	3/8"	54237-56
K81FA00	K81FG00	5-ported / 3 position APB	1/2"	54237-56
K81DA06	K81DG06	5-ported / 3 position COE	1/4"	54237-58
K81EA06	K81EG06	5-ported / 3 position COE	3/8"	54237-58
K81FA06	K81FG06	5-ported / 3 position COE	1/2"	54237-58
K81DA05	K81DG05	5-ported / 3 position COP	1/4"	54237-57
K81EA05	K81EG05	5-ported / 3 position COP	3/8"	54237-57
K81FA05	K81FG05	5-ported / 3 position COP	1/2"	54237-57

### Optional Connectors

Non-locking NPT Thread	Voltage
54934-01	Cable Grip, 0 - 240VAC/VDC
54934-21	6 ft molded cable, 0 - 204VAC/VDC
54934-08	Cable Grip, w/indicator light 24VDC
54934-02	Cable Grip, w/indicator light 120VAC
54934-05	1/2" Conduit 0 - 240 VAC/VDC
54934-30	6 ft molded cable, w/indicator light & surge suppression 24VAC/VDC
54934-35	6 ft molded cable, w/indicator light & surge suppression 120VAC/VDC