

RM/8000/M, ISO cylinder

Magnetic piston, double acting

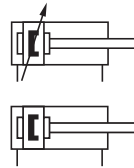

- > Ø 10 ... 25 mm
- > Magnetic piston as standard
- > Conforming to ISO 6432
- > Corrosion resistant With buffer or adjustable cushioning
- > Nose mounting nut and piston rod supplied locknut as standard



Technical features

Medium:

Compressed air, filtered, lubricated or non-lubricated

Standard:

ISO 6432

Operation:

Double acting with magnetic piston and buffer or adjustable cushioning

Operating pressure:

1 ... 10 bar (14 ... 145 psi)

Cylinder diameters:

10, 12, 16, 20, 25 mm (buffer)

16, 20, 25 mm (adjustable cushioning)

Strokes:

See page below

Non-standard strokes:

up to 1000 mm max. on request

Operating temperature:

-10 ... +80 °C max. (+14 ... +176 °F)

Air supply must be dry enough to avoid ice formation at temperatures below +2 °C (+35 °F).

Materials:

Barrel: stainless steel (austenitic)
End covers: clear anodised aluminium alloy
Piston rod: stainless steel (austenitic)
Buffer: PUR
Wiper: PUR
Seals: NBR

Technical data

Cylinder Ø (mm)	10	12	16	20	25
Port size	M5	M5	M5	G1/8	G1/8
Piston rod Ø (mm)	4	6	6	8	10
Piston rod thread	M4	M6	M6	M8	M10x1,25
Cushion length mm	—	—	16	19	19
Initial cushion volume (cm ³) *1)	—	—	2,4	4,4	7,2
Theoretical thrusts at 6 bar outstroke (N)	47,1	67,8	120	188	294
Theoretical thrusts at 6 bar instroke (N)	39,6	51	104	158	247
Air consumption at 6 bar outstroke (l/cm)	0,006	0,008	0,014	0,022	0,035
Air consumption at 6 bar instroke (l/cm)	0,005	0,006	0,013	0,019	0,028

*1) For cylinders with adjustable cushioning only



Standard strokes with buffer cushioning

Cylinder Ø (mm)	Stroke length (mm)									
	10	25	40	50	80	100	125	160	200	250
10	•	•	•	•	•	•	—	—	—	—
12	•	•	•	•	•	•	•	•	•	—
16	•	•	•	•	•	•	•	•	•	—
20	•	•	•	•	•	•	•	•	•	•
25	•	•	•	•	•	•	•	•	•	•

with adjustable cushioning

Cylinder Ø (mm)	Stroke length (mm)									
	10	25	40	50	80	100	125	160	200	250
16	—	•	—	•	•	•	•	•	•	•
20	—	•	—	•	•	•	•	•	•	•
25	—	•	—	•	•	•	•	•	•	•

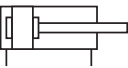
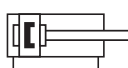
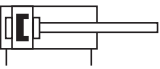
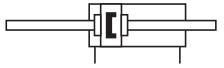
Cylinder variants

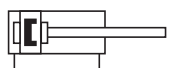
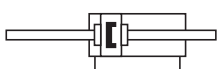
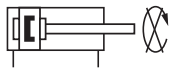
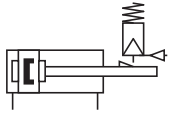
Symbol	Model Non-magnetic piston	Symbol	Model magnetic piston	Description	Dimensions Page
	TRM/8000 *1)		RM/8000/M	Standard cylinder with integral eye mounting	4
			RM/8000/MC	Cylinder with central rear port	5
			RM/8000/MF	Cylinder with flat rear cover	5
	RM/8000/IU TRM/8000/IU *1)		RM/8000/MU	Cylinder with extended piston rod piston rod extension 75 mm: *RM/8***/*U/stroke/75	4
			RM/8000/JM	Cylinder with double ended piston rod (Ø 16 to 25 mm)	4
			RM/8017/M	Cylinder Ø 16 mm with adjustable cushioning	4
			RM/8021/M	Cylinder Ø 20 mm with adjustable cushioning	4
			RM/8026/M	Cylinder Ø 25 mm with adjustable cushioning	4
			RM/8017/MU	Cylinder Ø 16 mm with adjustable cushioning and extended piston rod	4
			RM/8021/MU	Cylinder Ø 20 mm with adjustable cushioning and extended piston rod	4
			RM/8026/MU	Cylinder Ø 25 mm with adjustable cushioning and extended piston rod	4
			RM/8017/JM	Cylinder Ø 16 mm with double ended piston rod and adjustable cushioning	4
			RM/8021/JM	Cylinder Ø 20 mm with double ended piston rod and adjustable cushioning	4
			RM/8026/JM	Cylinder Ø 25 mm with double ended piston rod and adjustable cushioning	4
			RM/8000/N2	Cylinder with non-rotating piston rod (Ø 12 to 25 mm)	4
			RM/8000/L4	Cylinder Ø 12 to 25 mm with locking unit (PASSIVE). achieved by spring force on removal of the signal to the unit. Operating pressure for locking unit: 4 ... 10 bar	5

*1 Cylinder (Ø 16 ... 25 mm) with heat resistant seals 150 °C max.

Option selector

Non-standard variants	Substitute
High temperature version 150 °C max.	T
Cylinder Ø (mm) with buffer	Substitute
10	10
12	12
16	16
20	20
25	25
Cylinder Ø (mm) with adjustable cushioning	Substitute
16	17
20	21
25	26

Note: If option is not required, disregard option position within part number eg. RM/8025/M/50. For combinations of cylinder variants consult our Technical Service. Please note that heat resistant seals are not available for all variants. This options selector explains only the cylinder variants. Additional variants/options are not possible.









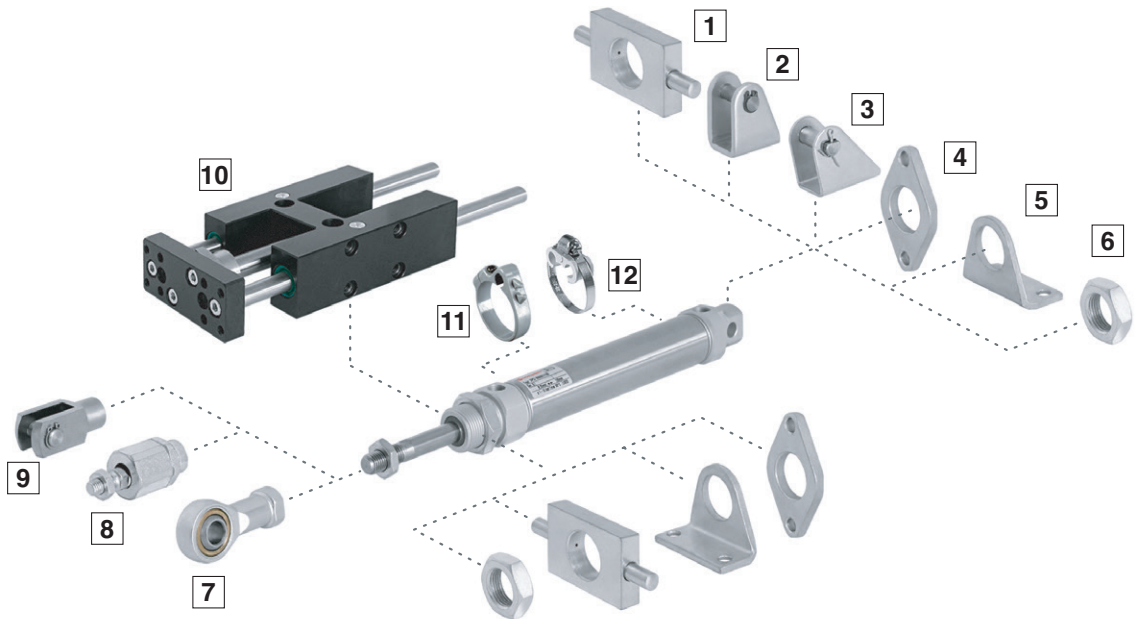



★RM/80★*/★*/★*

Stroke (mm)	Substitute
max. 1000	
Variants (non-magnetic piston)	Substitute
Extended piston rod RM/8***IU*/***/**	IU
Extension (mm)	
Variants (magnetic piston)	Substitute
Standard with integral eye mounting	M
Central rear port	MC
Flat rear cover	MF
Non-rotating piston rod	N2
Double ended piston rod	JM
Locking unit	L4
Extended piston rod RM/8***MU*/***/**	MU
Extension (mm)	

Note: Please fill in only the numbers of digits required, e.g. RM/8025/M/50

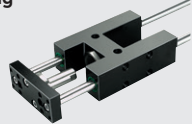
Mountings



Cyl.	AK	B, G	C	F	FH
					
	8	4	5	9	1
	Page 6	Page 6	Page 6	Page 6	Page 6
Ø	QM/8010/38	M/P19407	M/P19369	QM/8010/25	—
10	QM/8012/38	M/P19408	M/P19389	QM/8012/25	QM/8012/34
12	QM/8012/38	M/P19408	M/P19389	QM/8012/25	QM/8012/34
16	QM/8020/38	M/P19409	M/P19406	QM/8020/25	QM/8020/34
20	QM/8025/38	M/P19409	M/P19406	QM/8025/25	QM/8020/34
25					
Cyl.	L	L2	N	UF	Guide block with roler bearing
					
	3	2	6	7	10
	Page 6	Page 7	Page 7	Page 7	Page 8
Ø	QM/947	QM/8010/44	M/P1501/90	QM/8010/32	—
10	QM/8012/24	QM/8012/44	M/P13834	QM/8012/32	QM/8012/61/*
12	QM/8012/24	QM/8012/44	M/P13834	QM/8012/32	QM/8012/61/*
16	QM/8020/24	QM/8020/44	M/P13615	QM/8020/32	QM/8020/61/*
20	QM/8020/24	QM/8020/44	M/P13615	QM/8025/32	QM/8025/61/*
25					
Cyl.	Switch mounting brackets >15 mm stroke	<15 mm stroke	Magnetically operated switches		
					
	11	12	Page 10 ... 13		
	Page 10	Page 10			
Ø	QM/33/010/22	QM/33/010/23			
10	QM/33/012/22	QM/33/016/23			
12	QM/33/016/22	QM/33/016/23			
16	QM/33/020/22	QM/33/020/23			
20	QM/33/025/22	QM/33/025/23			
25					

* Please insert standard stroke length: Ø 12 mm: 50, 100, 160, 200 and 250 mm; Ø 16 ... 25 mm: 50, 100, 160, 200, 250, 320, 400 and 500 mm. For special strokes, use next larger standard stroke.

**Basic dimensions
RM/8000/M**

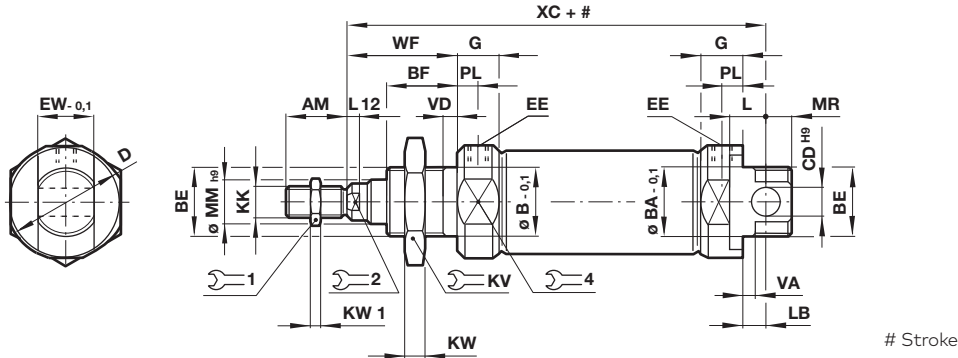
 Dimensions in mm
Projection/First angle

∅	AM	∅ B/BA -0,1	BE	BF	∅ CD H9	∅ D	EE	EW -0,1	G	KK		KW	KW1	L	Model
10	12	12	M12x1,25	12	4	16,5	M5	7,9	9	M4	19	6	2	6	RM/8010/M/*
12	16	16	M16x1,5	17	6	21	M5	11,9	9,5	M6	22	5	3	9	RM/8012/M/*
16	16	16	M16x1,5	17	6	21	M5	11,9	9,5	M6	22	5	3	9	RM/8016/M/*
20	20	22	M22x1,5	20	8	30	G1/8	15,9	15	M8	27	8	4	12	RM/8020/M/*
25	22	22	M22x1,5	22	8	30	G1/8	15,9	15	M10x1,25	27	8	5	12	RM/8025/M/*
∅	L12	LB	∅ MM h9	MR	PL		2	4	WF	VA/VD	XC	at 0 mm per 25 mm		Model	
10	-	2	4	8	5,5	7	-	14	16	1,5	64	0,034 kg	0,007 kg	RM/8010/M/*	
12	3	3	6	8	5,5	10	5	19	22	2	75	0,058 kg	0,011 kg	RM/8012/M/*	
16	3	4	6	7	5,5	10	5	19	22	2	82	0,070 kg	0,012 kg	RM/8016/M/*	
20	3	3	8	11	8	13	7	27	24	2	95	0,145 kg	0,018 kg	RM/8020/M/*	
25	4	7	10	9	8	17	9	27	28	2	104	0,200 kg	0,028 kg	RM/8025/M/*	

* Please insert standard stroke length.

**Alternative variants
RM/8017/M, RM/8021/M, RM/8026/M –
Cylinder with adjustable cushioning**

∅	at 0 mm	per 25 mm	Model
16	0,070 kg	0,012 kg	RM/8017/M/*
20	0,145 kg	0,018 kg	RM/8021/M/*
25	0,195 kg	0,028 kg	RM/8026/M/*

* Please insert standard stroke length.

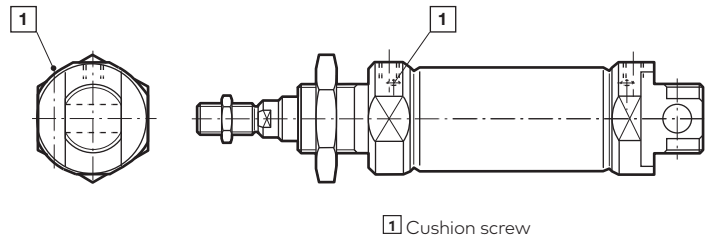

1 Cushion screw

**RM/8000/N2 –
Cylinder with non-rotating piston rod**

∅		Torque max.	at 0 mm	per 25 mm	Model
12	5	0,04 Nm	0,058 kg	0,011 kg	RM/8012/N2/*
16	5	0,04 Nm	0,070 kg	0,012 kg	RM/8016/N2/*
20	6	0,15 Nm	0,145 kg	0,018 kg	RM/8020/N2/*
25	8	0,25 Nm	0,200 kg	0,028 kg	RM/8025/N2/*

* Please insert standard stroke length.

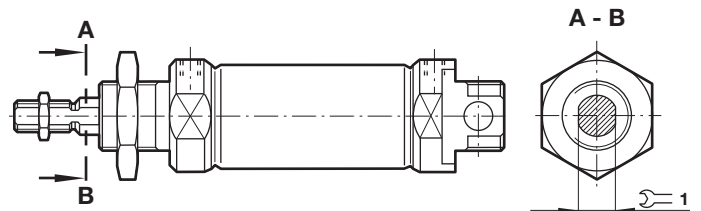

**RM/8000/JM –
Cylinder with double ended piston rod**

∅	L8	ZM	at 0 mm	per 25 mm	Model
16	56	100	0,080 kg	0,017 kg	RM/8016/JM/*
20	68	116	0,165 kg	0,028 kg	RM/8020/JM/*
25	69	125	0,250 kg	0,043 kg	RM/8025/JM/*

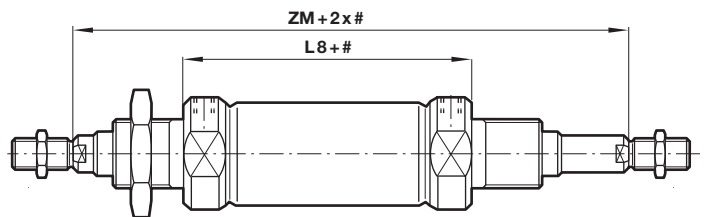
* Please insert standard stroke length.

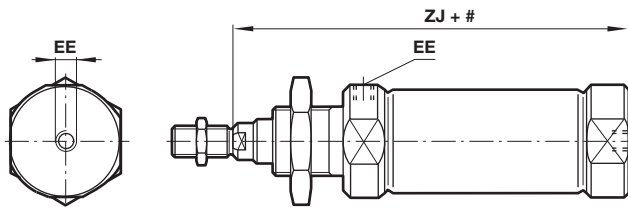

Stroke

Alternative variants
RM/8000/MC –
Cylinder with central rear port

RM/8000/MF –
Cylinder with flat rear cover

Dimensions in mm

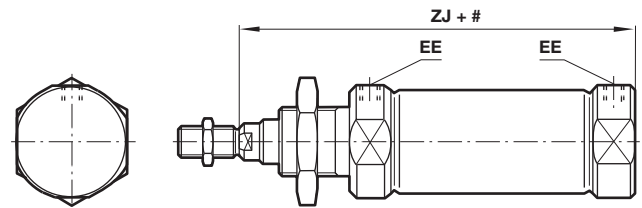
Projection/First angle



Stroke

Ø	EE	ZJ	at 0 mm	per 25 mm	Model
10	M5	62	0,031 kg	0,007 kg	RM/8010/M/*
12	M5	72	0,052 kg	0,011 kg	RM/8012/M/*
16	M5	78	0,064 kg	0,012 kg	RM/8016/M/*
20	G1/8	92	0,130 kg	0,018 kg	RM/8020/M/*
25	G1/8	97	0,185 kg	0,028 kg	RM/8025/M/*

* Please insert standard stroke length.

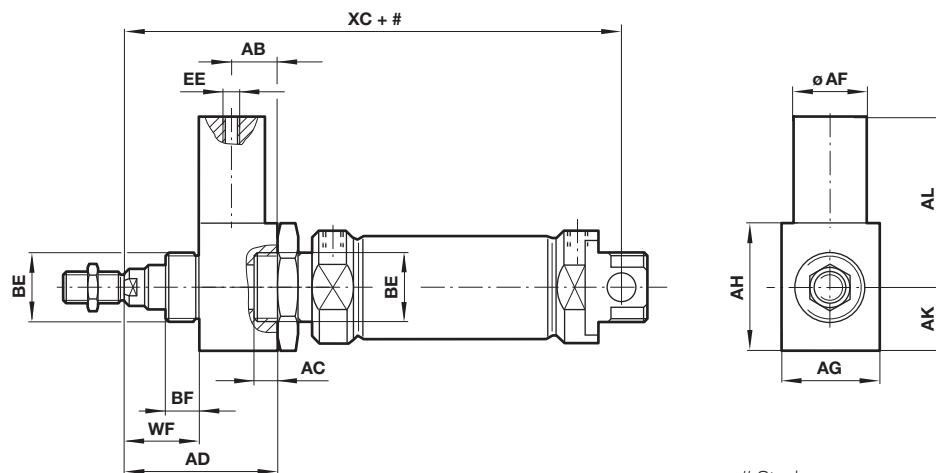
RM/8000/L4 – Cylinder with locking unit

Stroke

Ø	AB	AC	AD	Ø AF	AG	AH	AL	AK	Model
12	21	13	48,5	20	20	20	43,5	10	RM/8012/L4/*
16	21	13	48,5	20	20	20	43,5	10	RM/8016/L4/*
20	24	14	66	22	27	33	45,5	16,5	RM/8020/L4/*
25	24	14	65	22	27	33	45,5	16,5	RM/8025/L4/*

Ø	BE	BF	EE	WF	XC	Locking forces	at 0 mm	per 25 mm	Model
12	M16 x 1,5	12	M5	18,5	109	200 N	0,130 kg	0,011 kg	RM/8012/L4/*
16	M16 x 1,5	12	M5	18,5	116	200 N	0,140 kg	0,012 kg	RM/8016/L4/*
20	M22 x 1,5	23	M5	31	145	350 N	0,300 kg	0,018 kg	RM/8020/L4/*
25	M22 x 1,5	23	M5	30	151,5	400 N	0,360 kg	0,028 kg	RM/8025/L4/*

* Please insert standard stroke length.

Mountings
Piston rod swivel AK

Conforms to DIN ISO 8139

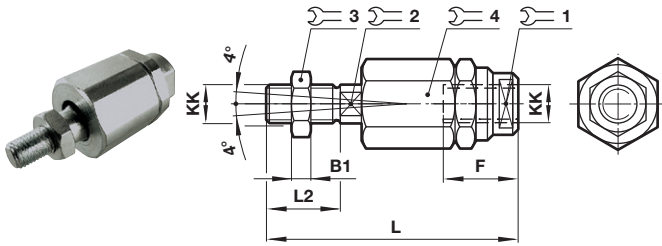

Ø	KK	B1	F	L	L2	1 2 3 4				kg	Model (AK)
						1	2	3	4		
10	M4	2	12,5	33	8	11	3,2	7	11	0,01	QM/8010/38
12/16	M6	3	14	39	12	7	5	10	13	0,02	QM/8012/38
20	M8	4	18	55	16	10	7	13	17	0,05	QM/8020/38
25	M10 x1,25	5	26	73	20	19	12	17	30	0,2	QM/8025/38

Front or rear flange G and B

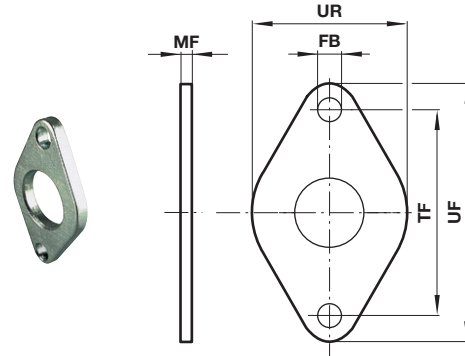
 Dimensions in mm
 Projection/First angle

Ø	Ø FB	MF	TF	UF	UR	kg	Model (B, G)
10	4,5	3	30	40	22	0,02	M/P19407
12/16	5,5	4	40	51	28	0,03	M/P19408
20/25	6,6	5	50	63	38	0,05	M/P19409

Foot C

Conforms to DIN ISO 6432

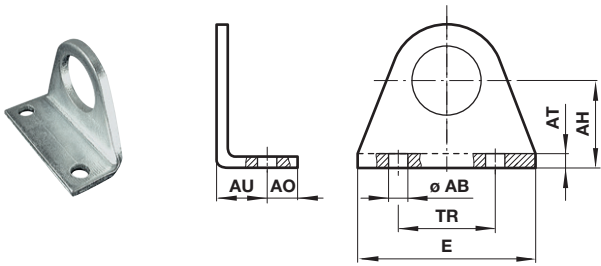

Ø	Ø AB	AH	AO	AT	AU	E	TR	kg	Model (C)
10	4,5	16	6	2	10	35	25	0,02	M/P19369
12/16	5,5	20	6	3	13	43	32	0,03	M/P19389
20/25	6,6	25	7,5	4	16	53	40	0,06	M/P19406

Piston rod clevis F

Conforms to DIN ISO 8140

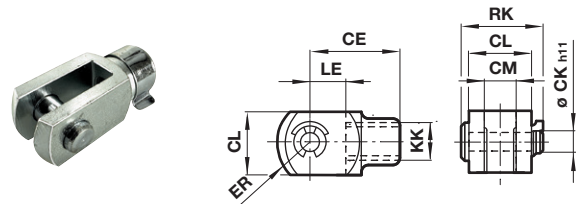

Ø	KK	CE	Ø CK h11	CL	CM	ER	LE	RK	kg	Model (F)
10	M4	16	4	8	4	6,5	8	11,5	0,01	QM/8010/25
12/16	M6	24	6	12	6	9,5	12	17,5	0,02	QM/8012/25
20	M8	32	8	16	8	13	16	22	0,06	QM/8020/25
25	M10 x1,25	40	10	20	10	16	20	28	0,10	QM/8025/25

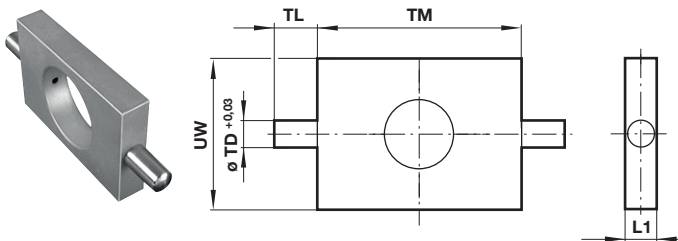
Front or rear detachable trunnion FH

Ø	L1	Ø TD +0,03	TL	TM	UW	kg	Model (FH)
12/16	8	6	10	38	25	0,05	QM/8012/34
20/25	8	6	10	46	30	0,07	QM/8020/34

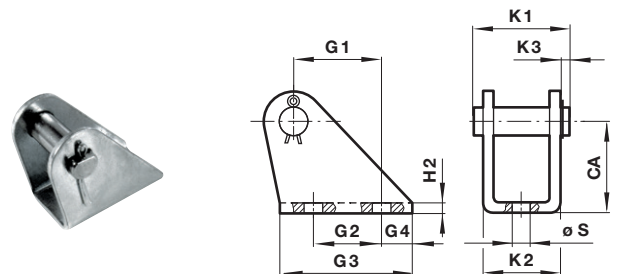
Rear hinge L

Ø	CA	G1	G2	G3	G4	H2	K1	K2	K3	Ø S	kg	Model (L)
10	12	6,5	-	15	6	1	13,5	10,5	2	4,8	0,01	QM/947
12/16	20	18,5	15	30	8	1,5	20	15	3	5,5	0,02	QM/8012/24
20/25	25	20	15	35	10	2	25	20,5	3	6,6	0,04	QM/8020/24

Rear hinge L2

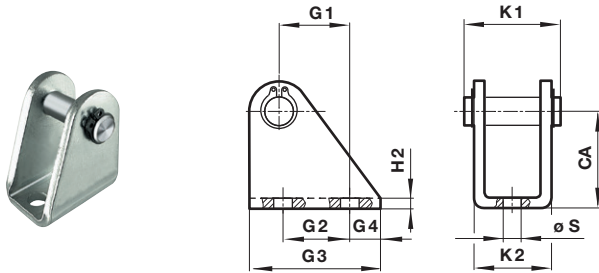

Ø	CA	G1	G2	G3	G4	H2	K1	K2	Ø S	kg	Model (L2)
10	24	11	12,5	20	4	2,5	17,5	13	4,5	0,018	QM/8010/44
12/16	27	13	15	25	5	3	23	18	5,5	0,035	QM/8012/44
20/25	30	16	20	32	6	4	29,5	24	6,6	0,077	QM/8020/44

Nose nut N

Dimensions in mm
Projection/First angle

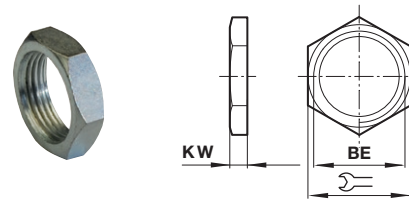

Ø	BE		KW	kg	Model (N)
10	M12x1,25	19	6	0,01	M/P1501/90
12/16	M16x1,5	22	5	0,01	M/P13834
20/25	M22x1,5	27	8	0,02	M/P13615

Universal piston rod eye UF Conforms to DIN ISO 8139

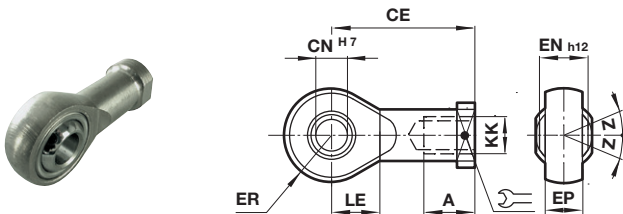

Ø	KK	AX	CE	Ø CN H7	EN -0,1	ER	LE	Z	kg	Model (UF)
10	M4	14	27	5	8	8	10	5°	0,02	QM/8010/32
12/16	M6	14	30	6	9	9	11	5°	0,02	QM/8012/32
20	M8	16	36	8	12	11	13	5°	0,05	QM/8020/32
25	M10 x 1,25	25	42	10	14	14	15	5°	0,08	QM/8025/32

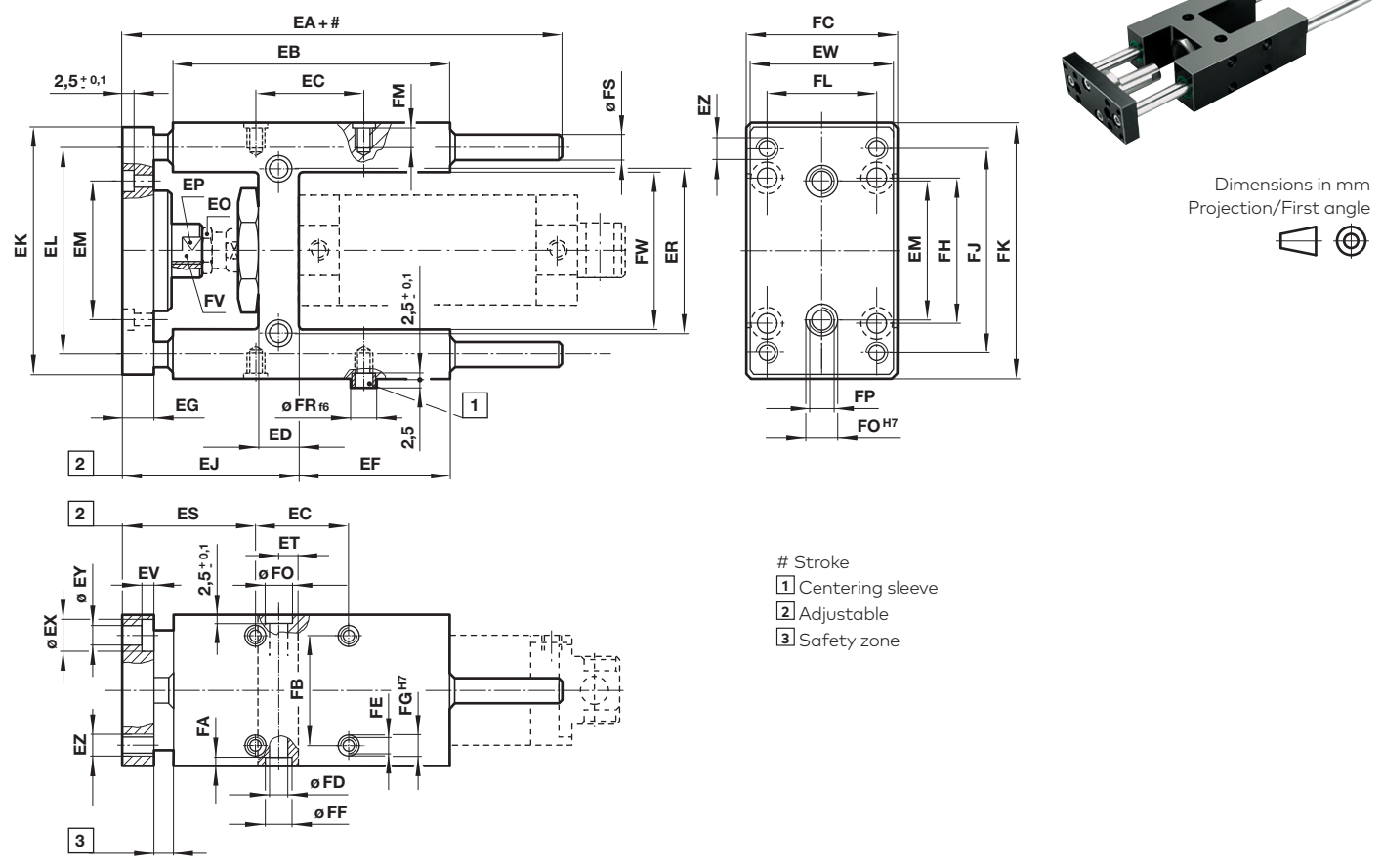
QM/8000/61 – Guide block

Ø	EA	EB	EC	ED	EF	EG	EJ	EK	EL	EM	EO	EP	ER	ES	ET	EV	EW	Ø EX	Ø EY	EZ	Model
12/16	132	75	32,5	16,5	37	10	76	63	46	24	10	8	24	65	6,5	4,6	27	8	4,5	M4	QM/8012/61
20	160	108	32,5	19	58	12	90	76	58	38	13	13	38	75	8,5	5,7	32	10	5,5	M5	QM/8020/61
25	160	108	32,5	19	58	12	90	76	58	38	17	13	38	75	8,5	5,7	32	10	5,5	M5	QM/8025/61
Ø	FA	FB	FC	Ø FD	FE	FF	Ø FG H7	FH	FJ	FK	FL	FM	Ø FO H7	FP	Ø FR f6	Ø FS	FV	FW	kg at 0 mm	kg per 100 mm	Model
12/16	6	22	30	5,5	M4	9	6	32	54	65	15	10	9	M5	6	8	M6	27	0,40	0,04	QM/8012/61
20	7	23	34	6,6	M6	11	9	40	68	79	20	14	9	M6	9	10	M8	37	0,65	0,06	QM/8020/61
25	7	23	34	6,6	M6	11	9	40	68	79	20	14	9	M6	9	10	M10 x 1,25	37	0,65	0,06	QM/8025/61

Note: supplied complete with cylinder mounting screws and two centering sleeves

Maximum load for QM/8000/61

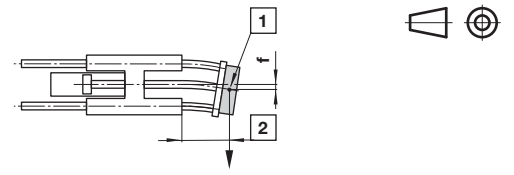
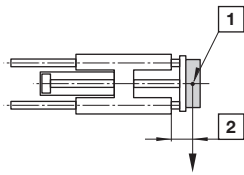

- 1 Centre of gravity load capacity
- 2 Outstroke

Maximum load capacity is dependent on the outstroke of a horizontally installed guide unit. In the case of short stroke operation, the load capacity figures taken from the diagram must be multiplied by the correction factor (diagram 2). In the curves of load capacity (diagram 1), the short stroke corrections have already been taken

into account for an outstroke > 60 mm.

The total deflection of guide rods will be determined by the addition of that due to own weight (diagram 3) and that due to load capacity (diagram 4).

Maximum load capacity depending on outstroke (diagram 1)

Load capacity

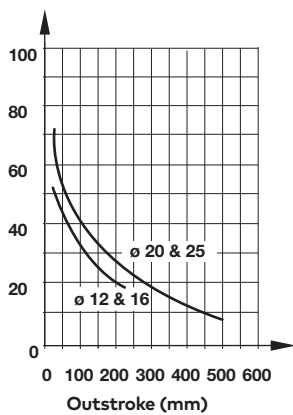

Correction factor

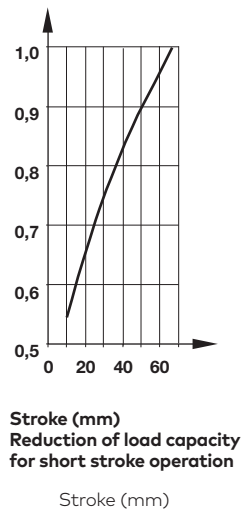

Deflection caused by own weight (diagram 3)

Deflection (mm)

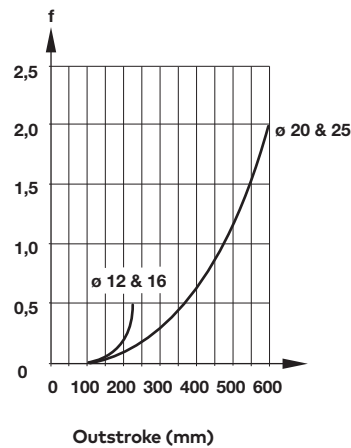

Deflection caused by a load of 10 N (diagram 4)

Deflection (mm)

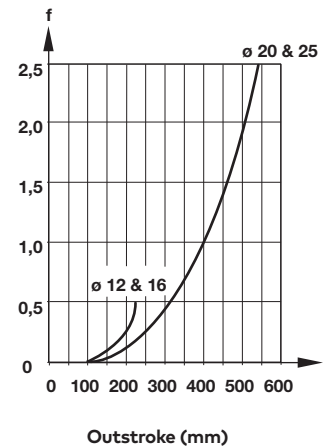

- > Magnetically operated reed switch - Round style
- > Suitable for all cylinder ranges with magnetic piston
- > LED indicator on LSU models
- > Alternative variants allows a wide range of application



Technical features

Operation:

M/50/LSU Normally open with LED (yellow)

Switching voltage (U_b):

10 ... 240 V a.c./170 V d.c.

Switching voltage output:

U_b - 2,7 V

Switching current

(see graph overleaf):

0,18 A max.

Switching power:

10 W/10 VA max.

Contact resistance:

150 mΩ

Response time:

1,8 ms

Operating temperature:

-25 ... +80 °C (-13 ... +176 °F)

High temperature version:

+150 °C max.(+302 °F)

Protection rating (EN 60529):

IP66

Shock resistance:

50 g (during 11 ms)

Vibration resistance:

35 g (at 2000 Hz)

Cable type:

2 x 0,25: PVC, PUR or silicone

3 x 0,25 PVC

Cable length:

2, 5 or 10 m

Electromagnetic compatibility

according to:

EN 60947-5-2

Materials:

Body: plastic

Cable: see table below

Technical data - Reed switches - additional information see data sheet en 4.3.005

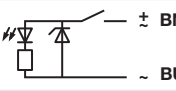
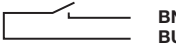
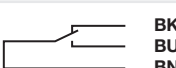
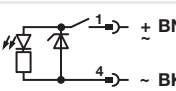
Symbol	Voltage		Current maximum (mA)	Function	Operating temperature (°C)	LED	Protection class	Plug	Cable length (m)	Cable type	Weight (g)	Model
	(V a.c.)	(V d.c.)										
	10 ... 240	10 ... 170	180	Normally open	-25 ... +80	•	IP 66	—	2,5 or 10	PVC 2 x 0,25	37	M/50/LSU/*V
	10 ... 240	10 ... 170	180	Normally open	-25 ... +80	•	IP 66	—	5	PUR 2 x 0,25	37	M/50/LSU/5U
	10 ... 240	10 ... 170	180	Normally open	-25 ... +150	—	IP 66	—	2	Silicon 2 x 0,25	37	TM/50/RAU/2S
	10 ... 240	10 ... 170	180	Changeover	-25 ... +80	—	IP 66	—	5	PVC 3 x 0,25	37	M/50/RAC/5V
	10 ... 60	10 ... 60	180	Normally open	-25 ... +80	•	IP 66	M8 x1	0,3	PVC 3 x 0,25	16	M/50/LSU/CP *1)
	10 ... 60	10 ... 60	180	Normally open	-25 ... +80	•	IP 66	M12 x1	0,3	PVC 3 x 0,25	16	M/50/LSU/CC *1)

* Insert cable length; *1) Plug-in connector see page 12

Dimensions

M/50/LSU/*V, M/50/LSU/5U,
TM/50/RAU/2S
Cable length L = 2, 5 or 10 m

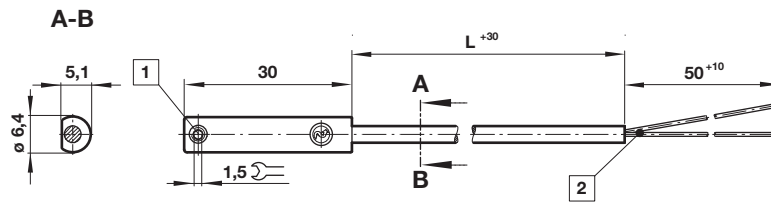

M/50/RAC/5V
Cable length L = 5 m

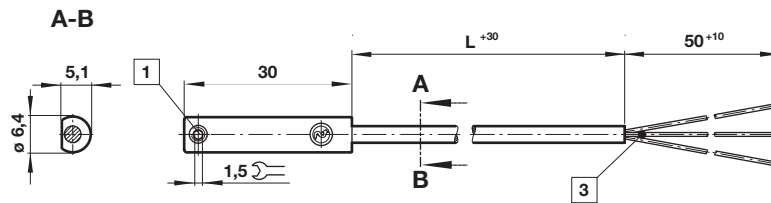

M/50/LSU/CP
M/50/LSU/CC

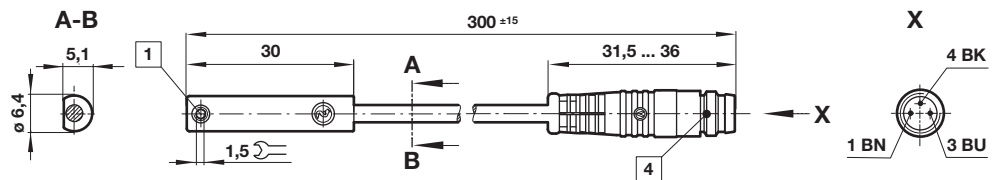

- 1 Fixing screw
- 2 + BN = brown; - BU = blue (output)
- 3 - BK = black; + BN = brown; - BU = blue
- 4 Version CP: Plug M8 x 1, color code: BK = +; BN = -; BU = output
Version CC: Plug M12 x 1, color code: BK = +; BN = -; BU = output

Dimensions in mm
Projection/First angle



- > Magnetically operated switch, solid state - round style
- > IO-Link version available
- > Suitable for all cylinder ranges with magnetic piston
- > Switches can be mounted flush in all profile cylinders
- > Reliable switching with a very fast response time
- > Particularly suited for use in high levels of vibration
- > LED indicator as standard
- > UL listed



Technical features

Operation:

PNP / NPN (see table)
Output with LED (yellow)
Normally open (standard)

Switching voltage (U_b):

10 ... 30 V d.c.
("supply class 2" acc. to cULus)

Voltage drop at output:

< 2,5 V

Residual current:

< 0,5 mA

Switching current

(see graph):

100 mA max. (standard)
300 mA max. (M/50/EHP)

Switching power:

3,0 W max. (standard)
9,0 W max. (M/50/EHP)

Response time:

< 0,1 ms (standard)
< 5 ms (M/50/IOP)

Operating frequency:

1 kHz (standard)
200 Hz (M/50/IOP)

Responsiveness:

2,8 mT

Hysteresis:

0,5 ... 1,5 mT
0,2 mT (M/50/IOP)

Repeatability:

< 0,1 mT

Protection rating (EN 60529):

IP67 (standard)
IP68 (M/50/EAP/5U, M/50/EHP/5U)

Operating temperature:

-40 ... +80 °C (-40 ... 176 °F)
(permanently fixed cable)
-25 ... +80 °C (-13 ... 176 °F)
(moving cable)

Cable type:

PVC 3 x 0,14 mm² (standard)
PUR 3 x 0,14 mm² (M/50/E*P/*U
and all variants with connector)

Cable length:

2, 5 and 10 m

Electromagnetic compatibility

according to:
EN 60947-5-2

Materials:

Housing: plastic
Thread insert: brass
Set screw: stainless steel
Cable: see table below

Mounting type:

Flush mountable

Technical data - Solid state - additional information see data sheet en 4.3.007

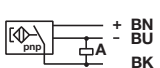
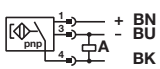
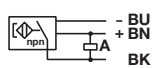
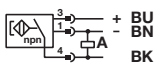
Symbol	Voltage (V DC)	Current maximum (mA)	Function	IO-Link *1)	Operating temperature (°C)	LED	Protection class	Connector	Cable length (m)	Cable type	Weight (g)	Model
	10 ... 30	100	PNP		-40 ... +80	•	IP67	---	2	PVC 3 x 0,14	23	M/50/EAP/2V
	10 ... 30	100	PNP		-40 ... +80	•	IP67	---	5	PVC 3 x 0,14	56	M/50/EAP/5V
	10 ... 30	100	PNP		-40 ... +80	•	IP67	---	10	PVC 3 x 0,14	102	M/50/EAP/10V
	10 ... 30	100	PNP / NPN	•	-40 ... +80	•	IP67	---	5	PVC 3 x 0,14	56	M/50/IOP/5V
	10 ... 30	100	PNP		-40 ... +80	•	IP68	---	5	PUR 3 x 0,14	56	M/50/EAP/5U
	10 ... 30	100	PNP		-40 ... +80	•	IP67	---	10	PUR 3 x 0,14	102	M/50/EAP/10U
	10 ... 30	300	PNP		-40 ... +80	•	IP67	---	2	PVC 3 x 0,14	23	M/50/EHP/2V
	10 ... 30	300	PNP		-40 ... +80	•	IP67	---	5	PVC 3 x 0,14	56	M/50/EHP/5V
	10 ... 30	300	PNP		-40 ... +80	•	IP67	---	10	PVC 3 x 0,14	102	M/50/EHP/10V
	10 ... 30	300	PNP		-40 ... +80	•	IP68	---	5	PUR 3 x 0,14	56	M/50/EHP/5U
	10 ... 30	100	PNP		-40 ... +80	•	IP67	M8 x 1	0,3	PUR 3 x 0,14	7	M/50/EAP/CP
	10 ... 30	100	PNP / NPN	•	-40 ... +80	•	IP67	M8 x 1	0,3	PUR 3 x 0,14	7	M/50/IOP/CP
	10 ... 30	100	PNP		-40 ... +80	•	IP67	M12 x 1	0,3	PUR 3 x 0,14	16	M/50/EAP/CC
	10 ... 30	100	PNP		-40 ... +80	•	IP67	M12 x 1	2	PUR 3 x 0,14	35	M/50/EAP/CC/2
	10 ... 30	100	PNP / NPN	•	-40 ... +80	•	IP67	M12 x 1	0,3	PUR 3 x 0,14	16	M/50/IOP/CC
	10 ... 30	300	PNP		-40 ... +80	•	IP67	M8 x 1	0,3	PUR 3 x 0,14	7	M/50/EHP/CP
	10 ... 30	100	NPN		-40 ... +80	•	IP67	---	2	PVC 3 x 0,14	23	M/50/EAN/2V
	10 ... 30	100	NPN		-40 ... +80	•	IP67	---	5	PVC 3 x 0,14	56	M/50/EAN/5V
	10 ... 30	100	NPN		-40 ... +80	•	IP67	---	10	PVC 3 x 0,14	102	M/50/EAN/10V
	10 ... 30	100	NPN		-40 ... +80	•	IP67	M8 x 1	0,3	PUR 3 x 0,14	7	M/50/EAN/CP

Color code: see next page

*1) IO-Link functionality: see next page

IO-Link Switch conforming to IEC 61131-9

Properties and Functionality	M/50/EAP, M/50/EAN M/50/EHP	M/50/IOP
Operating Mode	Standard	Standard
Power LED		• •
LED sensor signal	•	• •
Normally open (delivery status)	•	• •
Normally closed		○ •
Delay mode		○ •
Installation aid		• •
Temperature measurement		•
Detection counter		•
Teach functionality		•
Responsiveness adjustment		•

Note: IODD for the M/50/IOP switches available on the Norgren homepage.
<https://www.norgren.com/uk/en/technical-support/software>

• = included

○ = optional (manufacture pre-setting required)

Switching current and switching voltage

M/50/EAP, M/50/EAN, M/50/IOP

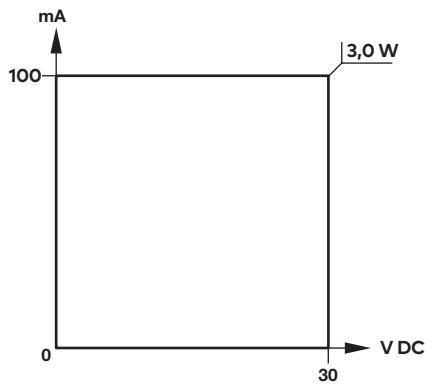

M/50/EHP

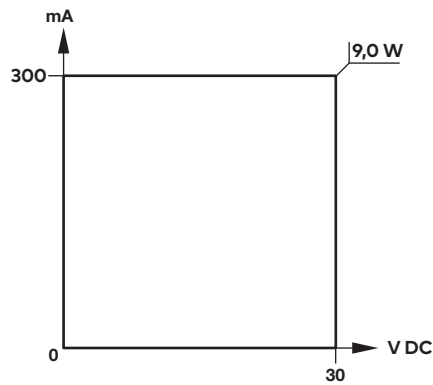

Dimensions

M/50/EAP/*V,
M/50/EAN/*U,
M/50/IOP/5V,
M/50/EHP/*V,
M/50/EHP/5U,
M/50/EAN/*V
Cable length L = 2, 5 or 10 m

Dimensions in mm
Projection/First angle



M/50/EAP/CP,
M/50/EAN/CP,
M/50/IOP/CP,
M/50/EHP/CP

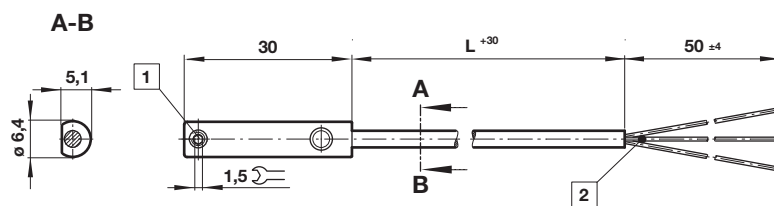

M/50/EAP/CC,
M/50/IOP/CC,
M/50/EHP/CC

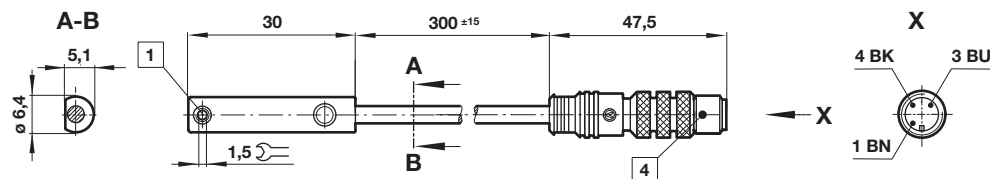
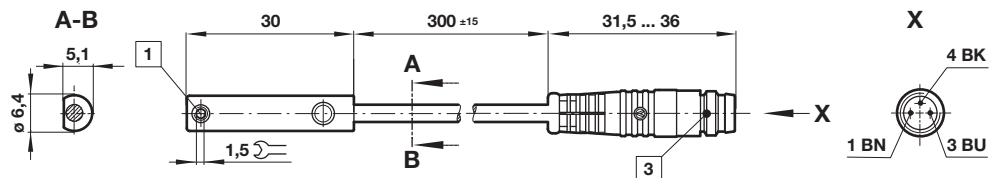

1 Fixing screw

2 Color code: BK = black (output); BN = brown (+); BU = blue (-)

3 Connector M8 x 1; 1 BN = +; 3 BU = -; 4 BK = output

4 Connector M12 x 1; 1 BN = +; 3 BU = -; 4 BK = output

Accessories

Plug-in connector cable with nut



Outer cover	Cable length (m)	Weight (kg)	Connector	Model
PVC 3 x 0,25	5	0,18	M8 x 1 straight connector	M/P73001/5
PUR 3 x 0,25	5	0,18	M8 x 1 straight connector	M/P73002/5
PVC 3 x 0,25	5	0,18	M8 x 1 angled connector 90 °	M/P34615/5
PUR 3 x 0,25	5	0,18	M8 x 1 angled connector 90 °	M/P34596/5
PUR 3 x 0,34	5	0,21	M12 x 1 straight connector	M/P34594/5

Switch mounting brackets - Brackets > 15 mm stroke



- 1 Magnetically operated switch
- 2 Switch mounting bracket

Ø	B	R max.	kg	Model
10	8	16	0,01	QM/33/010/22
12	8	18	0,01	QM/33/012/22
16	10	20	0,01	QM/33/016/22
20	10	22	0,01	QM/33/020/22
25	10	24	0,01	QM/33/025/22

Switch mounting brackets - Brackets < 15 mm stroke



- 1 Magnetically operated switch
- 2 Switch mounting bracket

Ø	S	T	kg	Model
10	27,5	19,5	0,01	QM/33/010/23
12	28,5	21,5	0,01	QM/33/016/23
16	29,5	23,5	0,01	QM/33/016/23
20	29,5	26	0,01	QM/33/020/23
25	31,5	28,5	0,01	QM/33/025/23

Warning

These products are intended for use in industrial compressed air systems only. Do not use these products where pressures and temperatures can exceed those listed under »**Technical features/data**«.

Before using these products with fluids other than those specified, for non-industrial applications, life-support systems or other applications not within published specifications, consult Norgren.

Through misuse, age, or malfunction, components used in fluid power systems can fail in various modes.

The system designer is warned to consider the failure modes of all component parts used in fluid power systems and to provide adequate safeguards to prevent personal injury or damage to equipment in the event of such failure.

System designers must provide a warning to end users in the system instructional manual if protection against a failure mode cannot be adequately provided.

System designers and end users are cautioned to review specific warnings found in instruction sheets packed and shipped with these products.